

ACSI

ARCHITECTURAL
CONTROL SYSTEMS INC.

CATALOG/PRICE BOOK #10

EFFECTIVE JANUARY 1, 2024

2720 Clark Avenue | St. Louis, Missouri 63103

1-800-753-5558 • 314-652-5588 • FAX: 314-652-2090

www.ACSI-INC.com

TERMS AND CONDITIONS OF SALE/WARRANTY

ACKNOWLEDGEMENT OF ORDER AND TERMS AND CONDITIONS OF SALE

This is to acknowledge receipt of your ("Buyer") purchase order for the specified ARCHITECTURAL CONTROL SYSTEMS, INCORPORATED ("Seller") products (the "Products") and to set forth the terms and conditions ("Terms and Conditions") of sale for this order. If the Terms and Conditions of this acknowledgment differ in any way from the terms and conditions of Buyer's order, this acknowledgment shall be construed as a counteroffer and shall not be effective as an acceptance of such order unless Buyer assents to the Terms and Conditions contained herein, which shall constitute the entire agreement (the "Agreement") between the parties. Buyer's assent to the Terms and Conditions contained herein shall be deemed given upon Buyer's execution of this acknowledgment below or upon Buyer's failure to object to these Terms and Conditions in writing within ten (10) days from the date of receipt of this acknowledgment. Buyer's receipt of delivery of the Products without immediate return will further manifest Buyer's assent to these Terms and Conditions. No additions to or modifications of any of the Terms and Conditions hereof shall be effective unless made in writing and signed by both parties.

- TAXES:** Any tax or governmental charge (or increase in same) affecting Seller's costs of production, sale, or delivery shall be for Buyer's account and shall be added to the price and shall not be subject to any discount.
- MINIMUM ORDER CHARGE:** The minimum invoice amount will be \$50.00. An order with a net value of less than \$50.00 will be invoiced at \$50.00.
- TERMS OF PAYMENT:** Terms are net thirty (30) days from the date of Seller's invoice in U.S. currency. Seller shall have the right, among other remedies, either to terminate this Agreement or to suspend further performance under this and/or other agreements with Buyer in the event Buyer fails to make any payment when due. Buyer shall be liable for all costs and expenses, including reasonable attorneys' fees, relating to the collection of past due amounts. If any payment owed to Seller is not paid when due, it shall bear interest at the maximum rate allowed by law from the date on which it is due until it is paid. Should Buyer's financial situation and/or capabilities become unsatisfactory to Seller in its sole discretion, cash payments or security satisfactory to Seller may be required by Seller for future deliveries and for the Products theretofore delivered.
- BACK CHARGES:** Seller is not responsible for, and will not accept, any charges for labor or material costs incurred for any installation, repair, service or replacement of the Products without the prior written consent of Seller.
- SHIPMENT AND DELIVERY:** Deliveries are made F.O.B. Seller's shipping point. Responsibility and risk of loss for damage shall pass from Seller to Buyer upon tender to, and receipt by, a common carrier at Seller's shipping point. Buyer hereby expressly waives any claims for shortages or damages suffered in transit against Seller and hereby agrees that any such claims shall be submitted by Buyer directly and only to the Buyer's insurance carrier. While Seller will use commercially reasonable efforts to maintain the delivery date(s) acknowledged or quoted by Seller, all shipping dates are approximate and not guaranteed. Seller reserves the right to make partial shipments. Seller, at its sole option, shall not be bound to tender delivery of any Products for which Buyer has not provided shipping instructions. If the shipment of the Products is postponed or delayed by Buyer for any reason, Buyer agrees to reimburse Seller for any and all storage costs and other additional expenses resulting therefrom.
- RETURN OF GOODS:** Products cannot be returned without the prior written consent of Seller. A 25% restocking and handling charge will be applied to returned Products, other than those which are returned for warranty repair or replacement. Additional service charges will apply to any damaged Products for restoration to saleable condition.
- LIMITED WARRANTY; LIMITATION OF REMEDY AND LIABILITY:** Subject to the limitations on remedies and liabilities set forth below, Seller warrants that the Products manufactured by Seller will be free from defects in material or workmanship under normal use and regular service and maintenance for one (1) year from the date of sale by Seller to Buyer. Determination of the suitability or fitness of the Products from the use or purpose contemplated by Buyer is the sole responsibility of Buyer, and Seller shall have no responsibility in connection with such suitability. The warranty set forth in this paragraph is Seller's sole warranty with respect to the Products.

SELLER MAKES NO OTHER WARRANTY OF ANY KIND WHATSOEVER, EXPRESS OR IMPLIED, INCLUDING, WITHOUT LIMITATION, ANY WARRANTY AGAINST INFRINGEMENT OF ANY THIRD PARTY'S INTELLECTUAL PROPERTY RIGHTS; AND ALL IMPLIED WARRANTIES OF MERCHANTABILITY AND FITNESS FOR A PARTICULAR PURPOSE ARE HEREBY DISCLAIMED BY SELLER AND EXCLUDED FROM THIS AGREEMENT.

Buyer agrees to examine and inspect the Products immediately upon arrival at their destination, and if the Products allegedly fail to comply with the limited warranty provided hereunder, Buyer shall give detailed written notice of such alleged failure/non-compliance to Seller within ten (10) days of its receipt of the Products. Any claim under this warranty shall conclusively be deemed waived by Buyer unless written notice thereof is given to Seller within ten (10) days after Buyer discovers, or should reasonably have discovered, the alleged failure/non-compliance of the Products, whichever is earlier. Buyer's exclusive remedy under this warranty is limited to the repair or replacement of the Products or the refund of the amount of the purchase price paid by Buyer, at Seller's sole option, upon the return of any nonconforming Products to Seller at Buyer's expense.

This limited warranty does not extend to any losses or damages due to misuse, accident, abuse, neglect, normal wear and tear, Buyer's negligence or intentional conduct, unauthorized modification or alteration, use beyond rated capacity, or improper installation, maintenance or application. To the extent that Seller has relied upon any specifications, information, representations of operating conditions or other data supplied by Buyer or its agents to Seller in connection with the design or manufacture of the Products, and in the event such specifications, information, representations or other data caused and/or contributed to the alleged failure/non-compliance of the Products, then any warranties contained herein shall be expressly waived by Buyer and be deemed null and void.

IT IS UNDERSTOOD AND AGREED THAT SELLER'S LIABILITY HEREUNDER OR IN CONNECTION WITH THE MANUFACTURE OR SALE OF THE PRODUCTS DESCRIBED HEREIN, WHETHER IN CONTRACT, IN TORT, FOR INFRINGEMENT, UNDER ANY WARRANTY, IN NEGLIGENCE OR OTHERWISE SHALL NOT EXCEED THE AMOUNT OF THE PURCHASE PRICE PAID BY BUYER. UNDER NO CIRCUMSTANCES SHALL SELLER BE LIABLE FOR SPECIAL, INCIDENTAL, INDIRECT OR CONSEQUENTIAL DAMAGES (INCLUDING, WITHOUT LIMITATION, ANY LOSS OF ANTICIPATED PROFITS INCURRED BY BUYER). THE PRICE STATED FOR THE PRODUCTS IS A CONSIDERATION IN LIMITING SELLER'S LIABILITY.

- EXCUSE OF PERFORMANCE (FORCE MAJEURE):** Seller shall not be liable for delays in performance or for non-performance due to acts of God; acts of Buyer; war; fire; terrorism or other criminal conduct; flood; weather; sabotage; strikes, or labor or civil disturbances; governmental requests, restrictions, laws, regulations, orders or actions; unavailability of or delays in materials, utilities or transportation; default of suppliers; or circumstances or any other events or causes beyond Seller's control. Deliveries or other performance may be suspended for an appropriate period of time or canceled by Seller upon notice to Buyer in the event of any of the foregoing, but the remainder of the Agreement shall otherwise remain unaffected as a result of the foregoing.
- If Seller determines that its ability to supply the total demand for the Products, or to obtain material used directly or indirectly in the manufacture of the Products, is hindered, limited or made impracticable, Seller may allocate its available supply of the Products or such material (without obligation to acquire other supplies of any such Products or material) among its purchasers on such basis as Seller determines to be equitable without liability for any failure of performance which may result therefrom.
- CANCELLATION:** Buyer may cancel orders only upon reasonable advance written notice and consent of Seller. If Seller consents to such cancellation, Buyer must pay Seller its cancellation charges which include, among other things, all costs and expenses incurred to cover commitments made by Seller, and a reasonable profit thereon. Seller's determination of such termination charges shall be conclusive.
 - CHANGES:** Buyer may request changes or additions to the Products consistent with Seller's specifications and criteria. In the event such changes or additions are accepted by Seller, Seller may revise the price(s) and date(s) of delivery.
Seller reserves the right to change designs and specifications for the Products without prior notice to Buyer, except with respect to Products being made-to-order for Buyer.
 - ASSIGNMENT:** Buyer shall not assign its rights or delegate its duties hereunder or any interest therein or any rights hereunder without the prior written consent of Seller, and any such assignment, without such consent, shall be void.
 - INSTALLATION:** Buyer shall be responsible for receiving, inspecting, testing, storing, installing, starting up, and maintaining all Products.
 - GENERAL PROVISIONS:** These Terms and Conditions supersede all other communications, negotiations and prior oral or written statements regarding the subject matter of these Terms and Conditions. No change, modification, rescission, discharge, abandonment, or waiver of these Terms and Conditions shall be binding upon Seller unless made in writing and signed on its behalf by a duly authorized representative of Seller. No conditions, usage of trade, course of dealing or performance, understanding or agreement purporting to modify, vary, explain, reject, or supplement these Terms and Conditions shall be binding unless hereafter made in writing and signed by the party to be bound, and no modification shall be affected by Seller's receipt, acknowledgment, or acceptance of purchase orders, shipping instruction forms, or other documentation containing terms at variance with or in addition to those set forth herein. No waiver by either party with respect to any breach or default or of any right or remedy and no course of dealing, shall be deemed to constitute a continuing waiver of any other breach or default or of any other right or remedy, unless such waiver be expressed in writing and signed by the party to be bound. All typographical or clerical errors made by Seller in any quotation, acknowledgment or publication are subject to correction. In the event that any work, phrase, clause, sentence, or other provision hereof shall be deemed unenforceable by a court of law and/or equity, such finding shall not invalidate all other enforceable provisions hereof.

The validity, performance, and all other matters relating to the interpretation and effect of this Agreement shall be governed by the laws of the state of Missouri, without giving effect to its conflict of laws rules. The application of the United Nations Convention on Contracts for the International Sale of Goods and the United Nations Convention on the Limitation Period in the International Sale of Goods to this Agreement are expressly excluded. Buyer and Seller agree that the proper and only venue for all actions arising from, relating to or in connection with this sale shall be the County of St. Louis, State of Missouri, where Seller's place of business is situated, and the parties agree to submit to such jurisdiction.



WWW.ACSI-INC.COM

LIST PRICES EFFECTIVE
JANUARY 1, 2024

Series 1100

Electric Hinges/Pivots

Hager
IVES
McKinney
BEST
PBB
Bommer
Rixson
ABH
and more

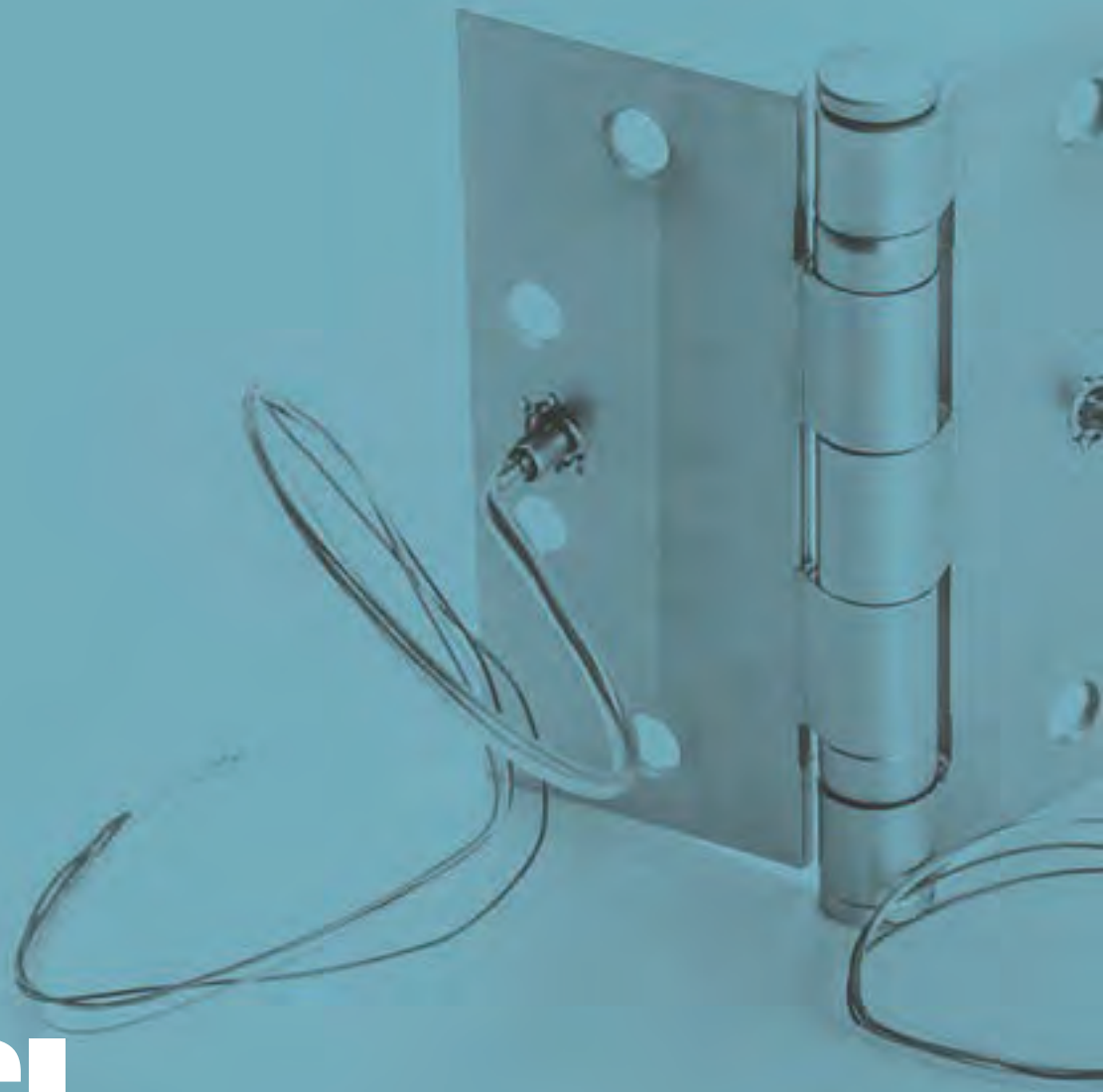

ACSI

2720 Clark Avenue
St. Louis, MO 63103
(314) 652-5588
(314) 652-2090 FAX

www.acsi-inc.com

Series 1100 | Electric Hinges/Pivots

ACSI Series 1100 Electric Hinges/Pivots are designed for doors that require concealed low voltage power transfer, concealed electric monitoring or concealed low voltage power transfer with monitoring. ACSI Series 1100 products are UL Listed and carry a full one-year warranty.

Manufacturers

Hager, IVES, McKinney, BEST, PBB, Bommer, Rixson, ABH, Dorma, Design Hardware, Don-Jo and more*

**Consult factory for manufacturers not listed*

- All IVES electric hinges supplied with Allegion connectors
- All McKinney electric hinges supplied with ASSA connectors

Options

- Custom wire lead lengths
- Universal Molex® Connectors
- Connectors available in Hager, ASSA or IVES specification

Features

- UL listed (UL File BP6073)
- UL Fire Rating on steel and stainless electric hinges (UL File R22305)
- Provide current transfer to electrified mortise or cylindrical locks, exit devices with electric latch retraction, electric strikes (pair of doors), & locks with monitoring/request to switches
- UL Rated for 3.5 amp continuous and a 16amp pulse
- Standard weight or heavy weight models
- Steel, brass, or stainless steel hinges
- Available in five knuckle and three knuckle hinges
- All architectural finishes in sizes 4x4 through 6x6
- Hinges/Pivots in stock for same day shipments

Notes

- Electric hinge must be placed in the center position only.
- ACSI requires NON-NRP hinges for modification. Hinge pin is not field removable after modification.
- ACSI part #302-03-03 mortar guard is required for all application with grout-filled frames. Failure to install mortar guard will void the electric hinge warranty.
- All "specialty hinges" not previously modified by ACSI will include a onetime \$250 design/engineering fee plus the hinge modification price.

Comparison Chart

ACSI	BEST	HAGER	McKINNEY	IVES
1104	CE-54	ETW-4	CC-4	TW4
1106	CE-56	ETW-6	CC-6	TW6
1108	CE-58	ETW-8	CC-8	TW8
1110	CS	EMN	CS	MON
1114	CECS-54	ETM-4	CSCC-4	TW4M
1116	CECS-56	ETM-6	CSCC-6	TW6M
1118	CECS-58	ETM-8	CSCC-8	TW8M

Models Available

Model	Description
1102	Concealed electric through-wire (2 wire, 22ga)
1104	Concealed electric through-wire (4 wire, 26/28ga)
1106	Concealed electric through-wire (6 wire, 26/28ga)
1108	Concealed electric through-wire (8 wire, 26/28ga)
1100-10	Concealed electric through-wire (10 wire, 26/28ga)
1100-12	Concealed electric through-wire (12 wire, 26/28ga)
1102x4	Concealed electric through-wire (2 wire, 22ga x 4 wire, 26/28ga)
1182*	Concealed electric through-wire (2 wire, 18ga)
1182x4*	Concealed electric through-wire (2 wire, 18ga x 4 wire, 26/28ga)
1182x6*	Concealed electric through-wire (2 wire, 18ga x 6 wire, 26/28ga)
1110	Concealed electric monitor
1114	Concealed electric monitor and through-wire (4 wire, 26/28ga)
1116	Concealed electric monitor and through-wire (6 wire, 26/28ga)
1118	Concealed electric monitor and through-wire (8 wire, 26/28ga)

** Not available in pivot modification*

How to Order

Manufacturer's Model	ACSI Model
BEST FBB179 4.5x4.5 26D	1104
Hager BB1279 5.0x4.5 10B	1108
Rixson M19 US26 LH	1110

Electrical Specifications

Concealed electric through-wire

- 22ga, 26ga, 28ga conductors, 12 inch wire lead length both sides
 - 3.5A continuous @ 50VAC/VDC
 - 16A pulse @ 50VAC/DC
 - 400msec maximum pulse-width
 - 10sec minimum off-time between pulses
- 18ga conductors, 12 inch wire lead length both sides
 - 10A continuous @ 50VAC/VDC
 - 20A inrush @ 50VAC/DC for 4sec

Concealed electric monitor

- 0.5A @ 30VDC



SERIES 1100

Electric Hinges/Pivots

Below pricing for hinges supplied by ACSI. Consult factory for hinges not listed.

Standard Weight, 5 Knuckle, Steel 4 wire			BB1279	5BB1	TA2714	FBB179
4.0x4.0	26D 652	1104	\$212	\$230	\$230	\$212
	10A/10B 641/640		224	244	244	224
	BLK 693		224	244	244	224
	3 632		224	244	244	224
	26 651		224	244	244	224
	10 639		224	244	244	224
	4 633		224	244	244	224
	P/BSP 600		224	244	244	224
4.5x4.0	26D 652	1104	\$206	\$224	\$224	\$206
	10A/10B 641/640		224	244	244	224
	BLK 693		224	244	244	224
	3 632		224	244	244	224
	26 651		224	244	244	224
	10 639		224	244	244	224
	4 633		224	244	244	224
	P/BSP 600		224	244	244	224
4.5x4.5	26D 652	1104	\$186	\$186	\$186	\$186
	10A/10B 641/640		190	208	208	190
	BLK 693		190	208	208	190
	3 632		190	208	208	190
	26 651		190	208	208	190
	10 639		190	208	208	190
	4 633		190	208	208	190
	P/BSP 600		190	208	208	190
5.0x4.0	26D 652	1104	\$224	\$244	\$244	\$224
	10A/10B 641/640		240	262	262	240
	BLK 693		240	262	262	240
	3 632		240	262	262	240
	26 651		240	262	262	240
	10 639		240	262	262	240
	4 633		240	262	262	240
	P/BSP 600		240	262	262	240

Series 1100 | Electric Hinges/Pivots

Standard Weight, 5 Knuckle, Steel 4 wire				BB1279	5BB1	TA2714	FBB179
5.0X4.5	26D 652	1104		\$216	\$234	\$234	\$216
	10A/10B 641/640			234	254	254	234
	BLK 693			234	254	254	234
	3 632			234	254	254	234
	26 651			234	254	254	234
	10 639			234	254	254	234
	4 633			234	254	254	234
	P/BSP 600			234	254	254	234
5.0x5.0	26D 652	1104		\$220	\$240	\$240	\$220
	10A/10B 641/640			234	254	254	234
	BLK 693			234	254	254	234
	3 632			234	254	254	234
	26 651			234	254	254	234
	10 639			234	254	254	234
	4 633			234	254	254	234
	P/BSP 600			234	254	254	234
Heavy Weight, 5 Knuckle, Steel 4 wire				BB1168	5BB1HW	T4A3786	FBB168
4.5X4.0	26D 652	1104		\$244	\$266	\$266	\$244
	10A/10B 641/640			262	286	286	262
	BLK 693			262	286	286	262
	3 632			262	286	286	262
	26 651			262	286	286	262
	10 639			262	286	286	262
	4 633			262	286	286	262
	P/BSP 600			262	286	286	262
4.5X4.5	26D 652	1104		\$236	\$256	\$256	\$236
	10A/10B 641/640			258	280	280	258
	BLK 693			258	280	280	258
	3 632			258	280	280	258
	26 651			258	280	280	258
	10 639			258	280	280	258
	4 633			258	280	280	258
	P/BSP 600			258	280	280	258

Series 1100 | Electric Hinges

Heavy Weight, 5 Knuckle, Steel 4 wire			BB1168	5BB1HW	T4A3786	FBB168
5.0x4.5	26D 652	1104	\$246	\$268	\$268	\$246
	10A/10B 641/640		270	294	294	270
	BLK 693		270	294	294	270
	3 632		270	294	294	270
	26 651		270	294	294	270
	10 639		270	294	294	270
	4 633		270	294	294	270
	P/BSP 600		270	294	294	270
5.0x5.0	26D 652	1104	\$252	\$274	\$274	\$252
	10A/10B 641/640		270	294	294	270
	BLK 693		270	294	294	270
	3 632		270	294	294	270
	26 651		270	294	294	270
	10 639		270	294	294	270
	4 633		270	294	294	270
	P/BSP 600		270	294	294	270
Standard Weight, 5 Knuckle, Brass or Stainless Steel 4 wire			BB1191	5BB1	TA2314	FBB191
4.5x4.0	26D 626	1104	\$242	\$264	\$264	\$242
	10B 613		246	268	268	246
	3 605		246	268	268	246
	26 625		246	268	268	246
	10 612		246	268	268	246
	4 606		246	268	268	246
	32 629		308	334	334	308
	32D 630		288	312	312	288
4.5x4.5	26D 626	1104	\$238	\$260	\$260	\$238
	10B 613		246	268	268	246
	3 605		246	268	268	246
	26 625		246	268	268	246
	10 612		246	268	268	246
	4 606		246	268	268	246
	32 629		298	326	326	298
	32D 630		278	304	304	278
5.0x4.5	26D 626	1104	\$270	\$294	\$294	\$270
	10B 613		284	310	310	284
	3 605		284	310	310	284
	26 625		284	310	310	284
	10 612		276	300	300	276
	4 606		276	300	300	276
	32 629		308	334	334	308
	32D 630		292	318	318	292

Series 1100 | Electric Hinges

Standard Weight, 5 Knuckle, Brass or Stainless Steel 4 wire			BB1191	5BB1	TA2314	FBB191
5.0x5.0	26D 626	1104	\$270	\$294	\$294	\$270
	10B 613		284	310	310	284
	3 605		284	310	310	284
	26 625		284	310	310	284
	10 612		276	300	300	276
	4 606		276	300	300	276
	32 629		316	344	344	316
	32D 630		306	332	332	306
Heavy Weight, 5 Knuckle, Brass or Stainless Steel 4 wire			BB1199	5BB1HW	T4A3386	FBB199
4.5x4.0	26D 626	1104	\$290	\$316	\$316	\$290
	10B 613		300	328	328	300
	3 605		300	328	328	300
	26 625		300	328	328	300
	10 612		300	328	328	300
	4 606		300	328	328	300
	32 629		346	376	376	346
	32D 630		324	352	352	324
4.5x4.5	26D 626	1104	\$290	\$316	\$316	\$290
	10B 613		300	328	328	300
	3 605		300	328	328	300
	26 625		300	328	328	300
	10 612		300	328	328	300
	4 606		300	328	328	300
	32 629		346	376	376	346
	32D 630		314	342	342	314
5.0x4.5	26D 626	1104	\$300	\$328	\$328	\$300
	10B 613		318	346	346	318
	3 605		318	346	346	318
	26 625		318	346	346	318
	10 612		318	346	346	318
	4 606		318	346	346	318
	32 629		368	400	400	368
	32D 630		332	362	362	332
5.0x5.0	26D 626	1104	\$300	\$328	\$328	\$300
	10B 613		318	346	346	318
	3 605		318	346	346	318
	26 625		318	346	346	318
	10 612		318	346	346	318
	4 606		318	346	346	318
	32 629		368	400	400	368
	32D 630		340	372	372	340

Series 1100 | Electric Hinges

Standard Weight, 3 Knuckle, Steel 4 wire			AB700	3CB1	TA714	CB1900
4.5x4.5	26D 652	1104	\$218	\$238	\$238	\$218
	10A/10B 641/640		234	254	254	234
	BLK 693		234	254	254	234
	3 632		234	254	254	234
	26 651		234	254	254	234
	10 639		228	250	250	228
	4 633		228	250	250	228
	P/BSP 600		228	250	250	228
5.0x4.5	26D 652	1104	\$234	\$254	\$254	\$234
	10A/10B 641/640		242	264	264	242
	BLK 693		242	264	264	242
	3 632		242	264	264	242
	26 651		242	264	264	242
	10 639		238	260	260	238
	4 633		238	260	260	238
	P/BSP 600		238	260	260	238
5.0x5.0	26D 652	1104	\$234	\$254	\$254	\$234
	10A/10B 641/640		242	264	264	242
	BLK 693		242	264	264	242
	3 632		242	264	264	242
	26 651		242	264	264	242
	10 639		238	260	260	238
	4 633		238	260	260	238
	P/BSP 600		238	260	260	238
Heavy Weight, 3 Knuckle, Steel 4 wire			AB750	3CB1HW	TA786	CB1901
4.5x4.5	26D 652	1104	\$292	\$318	\$318	\$292
	10A/10B 641/640		310	338	338	310
	BLK 693		310	338	338	310
	3 632		310	338	338	310
	26 651		310	338	338	310
	10 639		310	338	338	310
	4 633		310	338	338	310
	P/BSP 600		310	338	338	310
5.0x4.5	26D 652	1104	\$310	\$338	\$338	\$310
	10A/10B 641/640		326	354	354	326
	BLK 693		326	354	354	326
	3 632		326	354	354	326
	26 651		326	354	354	326
	10 639		326	354	354	326
	4 633		326	354	354	326
	P/BSP 600		326	354	354	326

Series 1100 | Electric Hinges

Standard Weight, 3 Knuckle, Brass or Stainless Steel 4 wire			AB800	3CB1	TA314	CB1960
4.5x4.5	26D 626	1104	\$288	\$312	\$312	\$288
	10B 613		346	376	376	346
	3 605		346	376	376	346
	26 625		346	376	376	346
	10 612		288	312	312	288
	32 629		326	354	354	326
	32D 630		326	354	354	326
5.0x4.5	26D 626	1104	\$314	\$342	\$342	\$314
	10B 613		368	400	400	368
	3 605		368	400	400	368
	26 625		368	400	400	368
	10 612		314	342	342	314
	32 629		358	390	390	358
	32D 630		358	390	390	358
5.0x5.0	26D 626	1104	\$314	\$342	\$342	\$314
	10B 613		334	364	364	334
	3 605		334	364	364	334
	26 625		334	364	364	334
	10 612		314	342	342	314
	32 629		358	390	390	358
	32D 630		358	390	390	358
Heavy Weight, 3 Knuckle, Brass or Stainless Steel 4 wire			AB850	3CB1HW	TA386	CB1961
4.5x4.5	26D 626	1104	\$320	\$350	\$350	\$320
	10B 613		380	412	412	380
	3 605		380	412	412	380
	26 625		380	412	412	380
	10 612		320	350	350	320
	32 629		372	406	406	372
	32D 630		372	406	406	372
5.0x4.5	26D 626	1104	\$356	\$388	\$388	\$356
	10B 613		412	450	450	412
	3 605		412	450	450	412
	26 625		412	450	450	412
	10 612		356	388	388	356
	32 629		396	432	432	396
	32D 630		396	432	432	396
5.0x5.0	26D 626	1104	\$356	\$388	\$388	\$356
	10B 613		412	450	450	412
	3 605		412	450	450	412
	26 625		412	450	450	412
	10 612		356	388	388	356
	32 629		396	432	432	396
	32D 630		396	432	432	396

Series 1100 | Electric Hinges Options (ADD TO 1104 LIST PRICE)

Model	Hinge Option Description	List Price
1106	Concealed electric through-wire (6 wire, 26/28 ga)	\$66
1108	Concealed electric through-wire (8 wire, 26/28 ga)	70
1100-10	Concealed electric through-wire (10 wire, 26/28 ga)	140
1100-12	Concealed electric through-wire (12 wire, 26/28 ga)	150
1102	Concealed electric through-wire (2 wire, 22 ga)	60
1102x4	Concealed electric through-wire (2 wire, 22 ga x 4 wire, 26/28 ga)	110
1182	Concealed electric through-wire (2 wire, 18 ga)	70
1182x4	Concealed electric through-wire (2 wire, 18 ga x 4 wire, 26/28 ga)	120
1182x6	Concealed electric through-wire (2 wire, 18 ga x 6 wire, 26/28 ga)	140
1110	Concealed electric monitor	24
1114	Concealed electric through-wire + monitor (4 wire)	186
1116	Concealed electric through-wire + monitor (6 wire)	220
1118	Concealed electric through-wire + monitor (8 wire)	234
1100-PG	Concealed electric through-wire (2 wire + ground, 18 ga) for 115V power transfer	450
ES	Exposed electric switch (1 switch)	Consult Factory
RC	Radius corner hinges	30
L	Long wire leads	Consult Factory
302 -03-03	7" Hinge mortar guard	44

Note: Consult factory for Swing Clear, Wide Throw, Half Mortise, Half Surface, Raised Barrel, Hospital Tips, and all other hinges not listed for price and availability.

Electric Pivots

Pivot	Finish	Model	List Price
M19	26D, 26, 10B, 3, 10, 4	1102/1104	\$660
M19	26D, 26, 10B, 3, 10, 4	1110	700
M19	26D, 26, 10B, 3, 10, 4	1108	680

Electric Hinges/Pivots Modifications

Below pricing for modifications to distrutor supplied hinges.

Model	Hinge Option Description	List Price
1104	Concealed electric through-wire (4 wire, 26/28 ga)	\$184
1106	Concealed electric through-wire (6 wire, 26/28 ga)	240
1108	Concealed electric through-wire (8 wire, 26/28 ga)	250
1100-10	Concealed electric through-wire (10 wire, 26/28 ga)	300
1100-12	Concealed electric through-wire (12 wire, 26/28 ga)	320
1102	Concealed electric through-wire (2 wire, 22 ga)	230
1102x4	Concealed electric through-wire (2 wire, 22 ga x 4 wire, 26/28 ga)	290
1182	Concealed electric through-wire (2 wire, 18 ga)	250
1182x4	Concealed electric through-wire (2 wire, 18 ga x 4 wire, 26/28 ga)	300
1182x6	Concealed electric through-wire (2 wire, 18 ga x 6 wire, 26/28 ga)	320
1110	Concealed electric monitor	190
1114	Concealed electric through-wire + monitor (4 wire, 26/28 ga)	360
1116	Concealed electric through-wire + monitor (6 wire, 26/28 ga)	400
1118	Concealed electric through-wire + monitor (8 wire, 26/28 ga)	440

Series 1100 | Electric Hinges/Pivots Modification Comparison Chart

ACSI	BEST	HAGER	IVES	McKINNEY
1104	CE-54	ETW-4	TW4	CC-4
1106	CE-56	ETW-6	TW6	CC-6
1108	CE-58	ETW-8	TW8	CC-8
1110	CS	EMN	MON	CS
1114	CECS-54	ETM-4	TW4M	CSCC-4
1116	CECS-56	ETM-6	TW6M	CSCC-6
1118	CECS-58	ETM-8	TW8M	CSCC-8

HOW TO ORDER (EXAMPLE)

Hinge/Part Description	Modification
FBB179 4.5x4.5 26D	1104
BB1279 5.0X4.5 10B	1108
M19-US26 LH	1110

Series 1200

Quick Connect Systems



ACSI

2720 Clark Avenue
St. Louis, MO 63103
(314) 652-5588
(314) 652-2090 FAX

www.acsi-inc.com

Series 1200 | Quick Connect Systems

ACSI Series 1200 Quick Connect Systems allow for trouble-free and time saving connections of electromechanical hardware openings. ACSI offers 3 types of connecting systems.

Systems	Description
QC1	ACSI Quick Connect System (Fits into a 3/8" door raceway)
QC2	ASSA Connect System
QC3	Allegion Connect System

QC1 ACSI Quick Connect System			
Model	Description	Length	Net Price
5C54M	5 Wire Power/Switch Harness, Male Connector 1 end	54"	\$20
5C120M	5 Wire Power/Switch Harness, Male Connector 1 end	120"	\$30

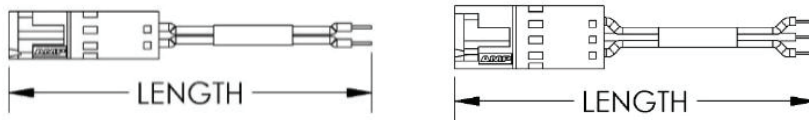

QC2 ASSA Connect System						
Model				Length	Net Price	Description
Male Connectors Both Ends		Male Connector 1 End/Pins 1 End				
12C3MM	QC-C003	12C3MP	QC-C003P	3"	\$14	Connecting electric hinge with electric exit device
12C6MM	QC-C006	12C6MP	QC-C006P	6"	\$15	
12C12MM	QC-C012	12C12MP	QC-C012P	12"	\$16	
12C26MM	QC-C200	12C26MP	QC-C200P	26"	\$17	Connecting electric hinge through the door with electric lockset
12C32MM	QC-C206	12C32MP	QC-C206P	32"	\$18	
12C38MM	QC-C300	12C38MP	QC-C300P	38"	\$19	
12C44MM	QC-C306	12C44MP	QC-C306P	44"	\$20	
12C50MM	QC-C400	12C50MP	QC-C400P	50"	\$21	
12C182MM	QC-C1500	12C182MP	QC-C1500P	182"	\$36	Connecting electric hinge to power supply or through metal door with full or half lite
		12C300MP	QC-C2500P	300"	\$48	
		12C360MP	QC-C3000P	360"	\$54	

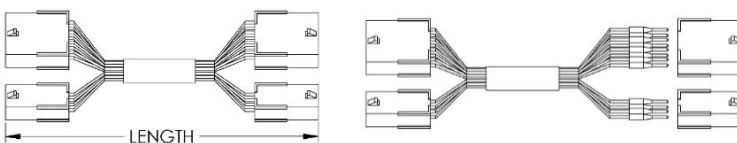

Series 1200 | Quick Connect Systems

QC3 Allegion Connect System CON

Model				Length	Net Price	Description
Male Connectors Both Ends		Male Connector 1 End/Pins 1 End				
12C6MM-AL	CON-6	12C6MP-AL	CON-6P	6"	\$15	Connecting electric hinge with electric exit device
12C12MM-AL	CON-12	12C12MP-AL	CON-12P	12"	\$16	
12C26MM-AL	CON-26	12C26MP-AL	CON-26P	26"	\$17	Connecting electric hinge through the door with electric lockset
12C32MM-AL	CON-32	12C32MP-AL	CON-32P	32"	\$18	
12C38MM-AL	CON-38	12C38MP-AL	CON-38P	38"	\$19	
12C44MM-AL	CON-44	12C44MP-AL	CON-44P	44"	\$20	
12C50MM-AL	CON-50	12C50MP-AL	CON-50P	50"	\$21	Connecting electric hinge to power supply or through metal door with full or half lite
12C192MM-AL	CON-192	12C192MP-AL	CON-192P	192"	\$42	

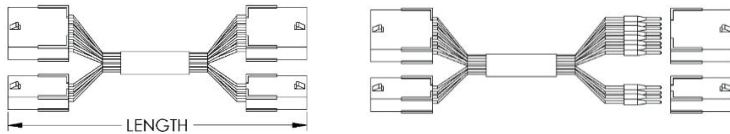

ASSA Connector Positions

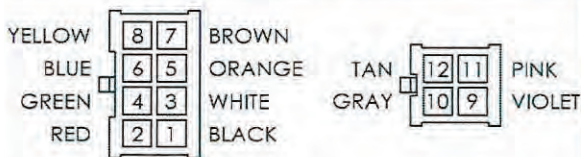

Allegion Connector Positions

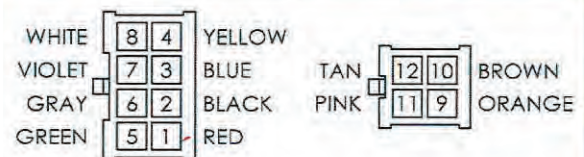

View from Back of Connectors (Terminal Insertion Side)



Series 1300

Door Controls

Mortise Keyswitches
Pushbutton Switches
Emergency Release
Door Position Sensors
Indicators
Digital Keypads

The ACSI logo is rendered in a large, bold, white sans-serif font. It is positioned in the bottom left corner of the page, partially overlapping the green background. The letters are thick and closely spaced, with the 'A' and 'C' being particularly prominent.









2720 Clark Avenue
St. Louis, MO 63103
(314) 652-5588
(314) 652-2090 FAX

www.acsi-inc.com

Series 1300 | Door Controls

Mortise Keyswitches



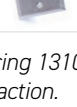





ACSI Series 1310 Mortise Keyswitches are designed to control electric locks, electric strikes, electric exit devices and a variety of other control applications. The keyswitches allow keying the electrically controlled openings to facility master key systems. DPDT contacts unless otherwise noted.

Model		Description	List Price
1310-1		Single gang, wall mount	\$156
1310-2		Single gang, 2 LEDs (red & green), wall mount	\$180
1310-4		Narrow style, 1-3/4" frame mount	\$168
1310-4-2		Narrow style, 2 LEDs (red & green), 1-3/4" frame mount	\$190
1310-5		Audible alarm, double gang, wall mount	\$264
1310-5-2		Audible alarm, double gang, 2 LEDs (red & green), wall mount	\$300
1310-6		Single gang, 2 momentary switches, wall mount	\$190
1310-7		Single gang, 2 momentary switches, 1 LED (red or green), wall mount	\$210
1310-8		Single gang, 2 momentary switches, 2 LEDs (red & green), wall mount	\$240
1310-9		Adjustable time delay, single gang, 1 LED (red or green), SPDT contacts, wall mount	\$300

*When ordering 1310 Keyswitches, specify momentary or maintained action.

Pushbutton Switches

ACSI Series 1320 Pushbutton Switches provide a variety of functions for commercial and industrial door control applications. DPDT contacts unless otherwise noted.

Model		Description	List Price
1320-1		Single gang, wall mount	\$120
1320-2		Single gang, 1 LED (red or green), wall mount	\$144
1320-3		Single gang, 2 LEDs (red & green), wall mount	\$168
1320-5		Mushroom button, single gang, SPDT contacts, wall mount*	\$500
1320-5-2		Mushroom button, single gang, 2 LEDs (red & green), SPDT contacts, wall mount*	\$550
1320-6		Narrow style, 1-3/4" frame mount	\$144
1320-6-2		Narrow style, 2 LEDs (red & green), 1-3/4" frame mount	\$180
1320-7		Adjustable time delay, single gang, 1 LED (red or green), SPDT contacts, wall mount	\$250

*When ordering 1320 Pushbuttons, specify momentary or maintained action.

Series 1300 | Door Controls

Emergency Release

ACSI 1330-3 Emergency Release provides manual emergency reporting; attractive/durable and finished in blue enamel.





Features

- UL Listed
- California State Fire Marshall approved
- Normally open or normally closed contacts
- Key resettable for increased security
- Designed for indoor or outdoor use
- Mounts in a standard single gang box
- Comes packaged with two spare keys, mounting hardware and one glass break tube

Model		Description	List Price
1330-3		Emergency Release	\$288







Door Position Sensors

ACSI Series 1335 Door Position Sensors are used to confirm door position. Magnetic sensors mounted in the frame react to the proximity of the magnet mounted in the door. Pneumatic models also available for use in hazardous locations.

Model		Description	List Price
1335-1		DPS Standard mortise, SPDT, NO/NC contacts	\$168
1335-2		DPS ANSI, SPDT, NO/NC contacts	\$190
1335-3		DPS 1" Recessed mount, SPDT, NO/NC contacts	\$80
1335-4		DPS Standard mortise, DPDT, NO/NC contacts	\$182
1335-5		DPS ANSI, DPDT, NO/NC contacts	\$200
1335-6		DPS 1" Recessed mount, DPDT, NO/NC contacts	\$110

Indicators

ACSI Series 1340 Indicators provide visual or audible indication of system status.

Model		Description	List Price
1340-1		Single gang, 1 LED (red or green), wall mount	\$72
1340-1-2		Single gang, 2 LEDs (red & green), wall mount	\$120
1340-2		Audible alarm, single gang, wall mount	\$144
1340-3		High security audible alarm, single gang, wall mount	\$192
1341-1		Narrow style, LED (Red or Green), 1 1/2" frame mount	\$72
1341-2		Narrow style, 2 LEDs (Red & Green), 1 1/2" frame mount	\$120

Electrical Specifications

1310/1320 Switches
• Contacts Rated 1A @ 30VDC
1330-3 Emergency Release Switch
• Separate NO/NC Outputs
• Can be wired for SPDT Contact Configuration
• Contacts Rated 1A @ 30VDC
1340-2 & 1340-3 Audible Alarm
• DC Voltage Range: 4V - 28V
• DC Current Range: 3mA - 16mA
• Frequency: 2900 Hz
• Sound Intensity: 64dB @ Min.V; 76dB @ Max.V
Red/Green LED Indicator used with 1310/1320/1340 Controls
• 20mA @ 24VDC

Series 1300 | Door Controls





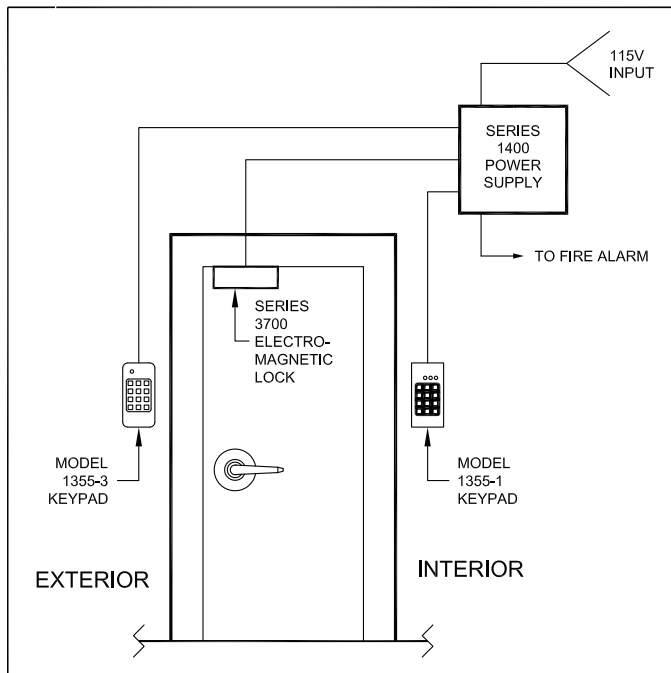

Digital Keypads

ACSI Series 1355 Digital Keypads offer proven reliability for commercial, industrial and residential applications. The keypads are designed to control any electric locking device.

Features

- Keypad programmable
- 10-30 VDC; 12-24VAC-auto adjusting (12-24VAC/DC for 1355-5)
- 120 user capability
- Codes can be 1 to 6 digits including repeated digits
- 1-90 sec. adjustable relock delay (1-255 sec. for 1355-6)
- LED status indicators (for all models except 1355-4)
- Request-to-exit switch input
- Main relay ON/OFF latching (toggle mode)
- Panic output (for all models except 1355-5 and 1355-6)
- Remote alarm panel interface capability
- Main relay: 5A, form C @ 24VDC with 10A surge (2A for 1355-3, 1355-4 and 1355-6)
- Non-volatile memory remembers codes and instructions when power is removed



Model		Description	List Price
1355-1		Digital Indoor Keypad	\$264
1355-2		Weather Resistant Keypad	\$384
1355-3		Sealed Environmental Keypad • Weather resistant, self-contained metal housing • Vandal resistant • Small design suitable for commercial, industrial and residential applications	\$816
1355-4		Ruggedized Digital Keypad • Weather resistant, self-contained metal housing • Vandal resistant • One piece housing suitable for wall, post or gooseneck mounting • Internal audible multi-status indicator (sounder) • Available in white or black	\$816
1355-6		Indoor/Outdoor Backlit Keypad • Weather resistant • Illuminated backlit hardened keys • Flush mount design • Includes audible indicator (sounder)	\$540
1355-7		Harsh Environment Keypad • Vandal and weather resistant case • Indoor/outdoor applications • Touch sensitive flat key design • 12/24 volts AC/DC jumper selectable	\$1,032

Series 1400

Power Supplies

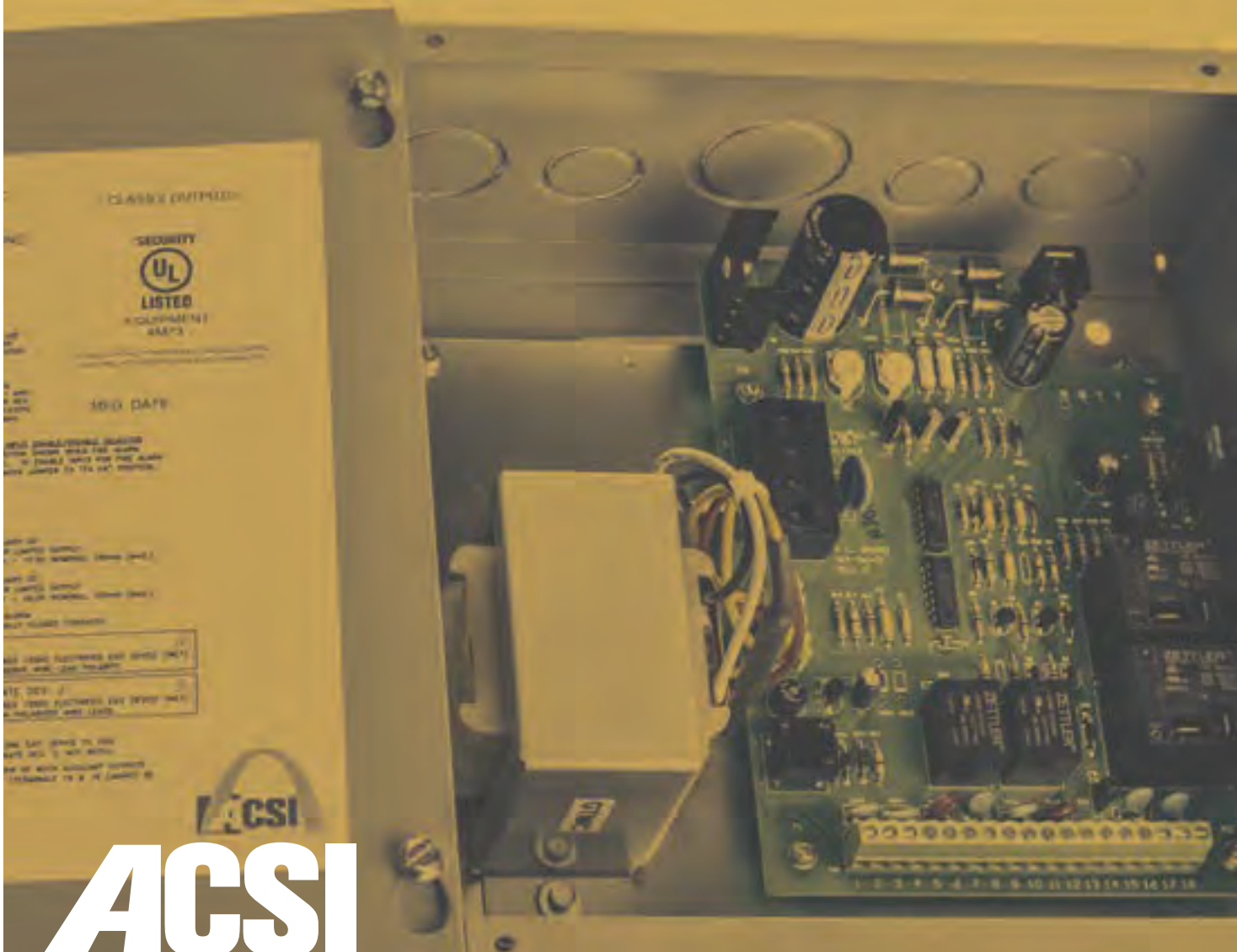

2720 Clark Avenue
St. Louis, MO 63103
(314) 652-5588
(314) 652-2090 FAX

www.acsi-inc.com

Series 1400 | Power Supplies

1406/1426 Power Supplies

ACSI 1406 and 1426 Power Supplies are designed to operate exit devices equipped with ACSI Series 1550 Electric Latch Retraction (required with 1550 Electric Solenoid Latch Retraction).

Features

- UL Listed and tested to UL 294 standard
- Class 2 rated outputs
- 2A load capacity
- Overload, over voltage, and short circuit protection
- 1406 Series only: select from independent control of single exit devices from separate inputs (one or two single doors) or sequential operation of two exit devices from a single input (pair of doors)
- Automatic door operator interface
- Fire alarm interface
- Field adjustable latch retraction time delay
- 24VDC, 12VDC* constant voltage outputs (250mA each)

*Not available in battery backup models

Day/Night Mode-ACSI 1426 Power Supply

Provides a separate input for retracting one exit device or two exit devices sequentially without activating the automatic door operator. While the latches are held retracted, the auto-operator can be activated independently from a different input.

1406BB/1426BB Power Supplies with Battery Backup

All the same features as above, but includes built-in battery backup power:

- 4 hours of backup power at full load during AC power failure
- Standby battery power with a supervised AC failure output and low battery output
- Supplied with (2) 12V, 7Ah lead acid batteries

ACSI 1406 Application

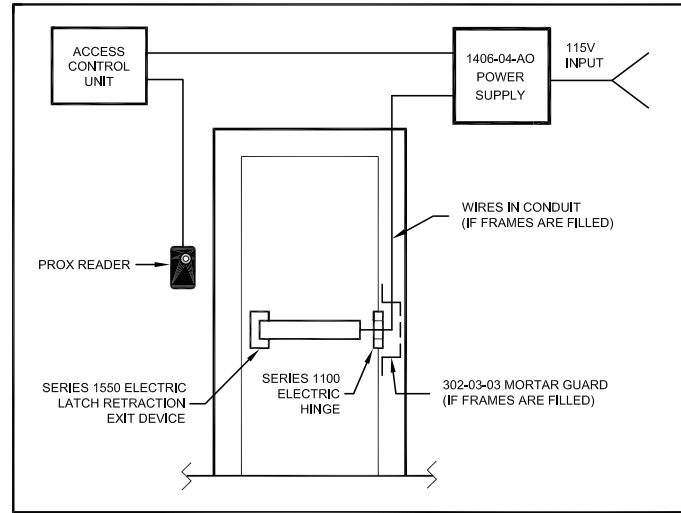

ACSI 1426 Application

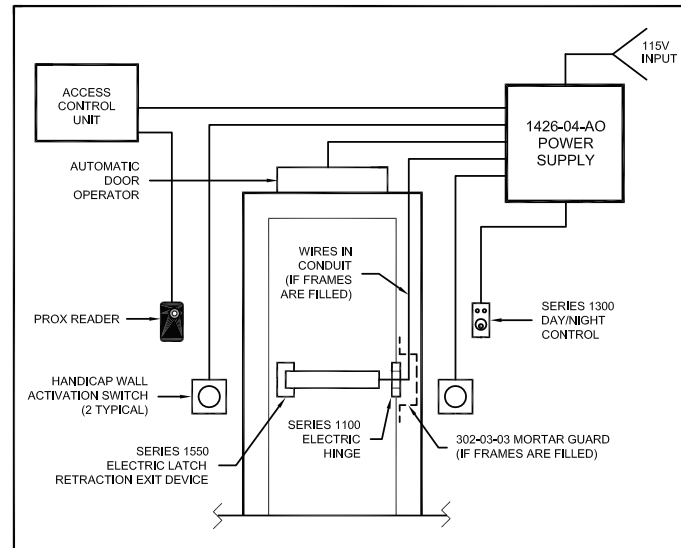

1406



1406BB

Model	Description	List Price
1406	1550 electric latch retraction	\$690
1426	1550 electric latch retraction, day/night mode	\$700
1406BB	1406, battery backup	\$1,180
1426BB	1426, battery backup	\$1,200



Series 1400 | Power Supplies

1410 Interlock Power Supply

ACSI 1410 Interlock Power Supply is designed to interconnect two or more doors using fail safe locking devices. Each supply can control up to four doors and the system can be expanded for requirements in excess of four doors. Any one door can be programmed to be a part of (common to) as many as three separate interlocking systems. Separate plug-in p.c. boards used to control interlocking doors can be programmed for normally locked or normally unlocked operation.

Inputs are available for fire alarm and optional emergency release interface for override of the interlocking system. Applications include darkrooms, laboratories, pharmaceuticals, detention centers, money counting rooms, airlocks, clean rooms, etc.

ACSI system engineers are available for design and consultation services to coordinate all aspects of the system. ACSI electric locking systems and all documentation including riser diagrams and point-to-point wiring diagrams can give distributors a single source for their system requirements.

Features

- UL Listed and tested to UL 294 standard
- Filtered/Regulated 24VDC
- Class 2 rated outputs
- 2.2A load capacity
- Overload, over voltage, and short circuit protection
- Automatically accepts 120VAC or 240VAC input



1410-4

Model	Description	List Price
1410-2	2 Door Interlock	\$980
1410-3	3 Door Interlock	\$1,300
1410-4	4 Door Interlock	\$1,500

ACSI Interlock System

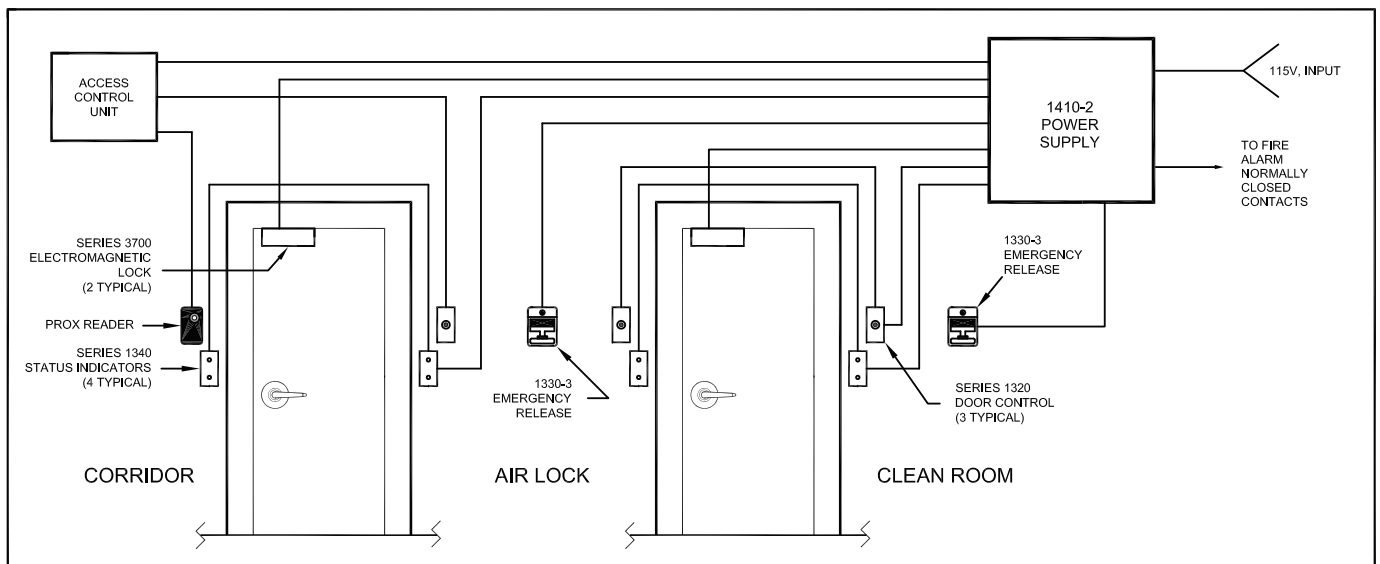

Series 1400 | Power Supplies

1420 Power Supply

ACSI 1420 Power Supply can be used in the following applications:

- Provide power/control to exit devices equipped with the ACSI Series 1550-MD Motor Drive Electric Latch Retraction. (See ACSI Series 1500 Electric Exit Device Catalog)
- Provide power/control to electrified door hardware in applications requiring automatic door operator interface.

Features

- UL Listed and tested to UL 294 standard
- Filtered/Regulated 24VDC
- Class 2 rated outputs
- 2A load capacity
- Overload, over voltage, and short circuit protection
- Automatically accepts 120VAC or 240VAC input

Each 1420 Includes

- Separate inputs for activation switch on entry and exit sides of the opening.
- Relay dry contact output to automatic door operator input.
- Built-in 0.5 second time delay between activation of the electrified door hardware and automatic door operator.
- Input for optional fire alarm or emergency release switch when urgent unlocking of door is required.
- Auxiliary 24VDC constant voltage output
- Separate 24VDC outputs for fail safe and fail secure electrified door hardware.

Options

DN – Day/Night mode provides a separate input for retracting one exit device or two exit devices simultaneously without activating the automatic door operator. While the latches are held retracted, the auto-operator can be activated independently from a different input.

ACSI Automated Door Opening System

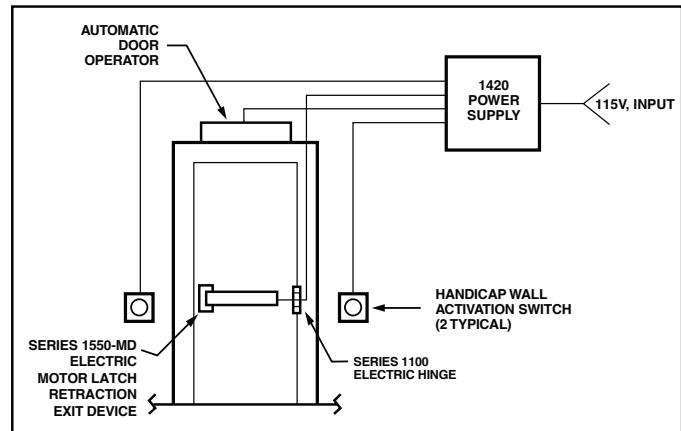

1420

Model	Description	List Price
1420	24VDC, 2A automatic operator interface	\$460
1420-DN	1420, day/night mode	\$520



Series 1400 | Power Supplies

1440 Power Supply

ACSI 1440 Power Supply provides power for fail safe or fail secure locking devices.

Features

- UL Listed and tested to UL 294 standard
- Filtered/Regulated 24VDC
- Class 2 rated outputs
- 2A load capacity
- Overload, over voltage, and short circuit protection
- Surge suppression on fail safe and fail secure outputs
- Automatically accepts 120VAC or 240VAC input

Each 1440 Includes

- Interface relay to isolate the locking device current from the control switch
- Auxiliary 24VDC constant voltage for powering standalone devices such as keypads, motion detectors, status indicators, etc.
- Field terminal block set at 45° for ease of installation

Options

TD – Adjustable time delay for 1 second to 60 minutes

Model	Description	List Price
1440	24VDC, 2A	\$420
1440-TD	1440, adjustable time delay	\$510

ACSI Locking System

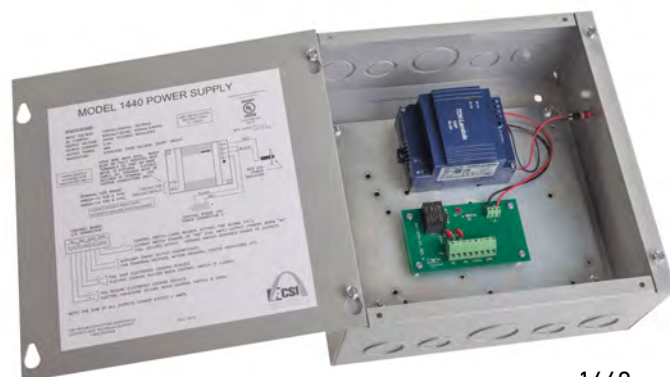
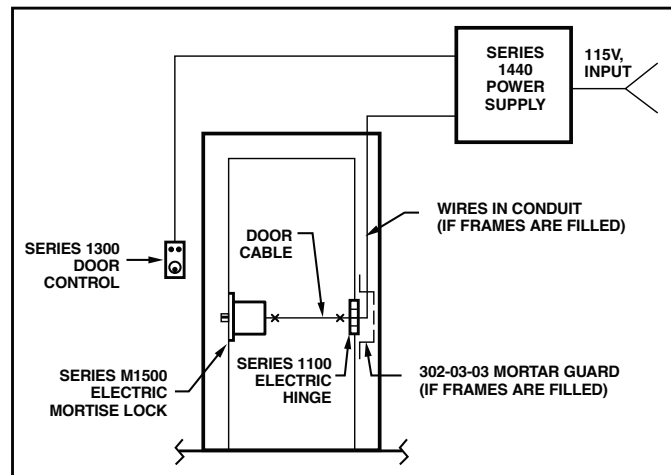

1440



Series 1400 | Power Supplies

1451/1452 Power Supplies with Battery Backup

ACSI 1451 and 1452 Power Supplies can be used in the following applications:

- Provide power/control to exit devices equipped with the ACSI Series 1550-MD Motor Drive Electric Latch Retraction. (See ACSI Series 1500 Electric Exit Device Catalog)
- Provide power/control to electrified door hardware in applications requiring automatic door operator interface.
- Provide power for fail safe or fail secure locking devices.

Features

- 1451-1A load capacity
- 1452-1.75A load capacity
- UL Listed for US and Canada
- Filtered/Regulated 12VDC or 24VDC
- Class 2 rated outputs
- Fire alarm interface
- Overload and short circuit protection
- Automatic switchover to standby battery when AC fails
- Built-in battery charger
- Supplied with (2) 12V, 7Ah lead acid batteries

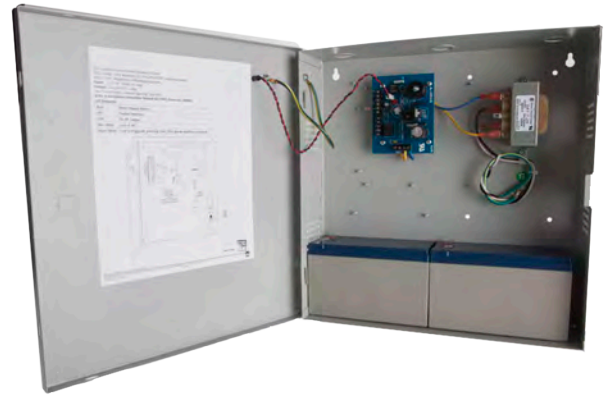

1451

Options

- TD – Adjustable time delay for 1 second to 60 minutes
- DN – Day/Night mode provides a separate input for retracting one exit device or two exit devices simultaneously without activating the automatic door operator. While the latches are held retracted, the auto operator can be activated independently from a different input.
- AO – Automatic Operator Interface



1452

Model	Description	List Price
1451	12VDC or 24VDC, 1A, battery backup	\$700
1451-TD	1451, adjustable time delay	\$720
1451-DN	1451, day/night mode	\$810
1451-AO	1451, automatic operator interface	\$780
1452	12VDC or 24VDC, 1.75A, battery backup	\$700
1452-TD	1452, adjustable time delay	\$730
1452-DN	1452, day/night mode	\$820
1452-AO	1452, automatic operator interface	\$790



Series 1400 | Power Supplies

1490 Delayed Egress Power Supply

ACSI 1490 Power Supply is designed to interface with ACSI electromagnetic locks in a delayed egress locking application.

Features

- UL Listed
- Compliance with NFPA code requirements
- Filtered/Unregulated 24VDC
- 2A load capacity
- Input for delayed egress activation
- Manual reset of delayed egress alarm
- Optional auto reset available
- Fire alarm interface
- Output for audible alarm
- Field adjustable delay for nuisance alarm, door release, request-to-exit and auto reset delay times
- One power supply can provide up to 4 delayed egress alarm zones

Description of System Operation

The delayed egress alarm becomes activated when the push bar of the Series 1500 modified exit device is depressed. A concealed AE (request-to-exit) switch initiates an irreversible cycle that begins with the Series 1300 audible alarm sounding for a predetermined time (field adjustable) while the Series 3700 electromagnetic lock remains energized locking the door.

At the end of the timing cycle, the electromagnetic lock de-energizes and unlocks the door while the audible alarm continues sounding. The door will remain unlocked and in an alarm state until manually reset by the Series 1300 keyswitch. Resetting the system will lock the door by energizing the electromagnetic lock and will turn off the audible alarm.

Note: When using the system with a door position switch, the door must be fully closed prior to resetting the system. Resetting with the door open will energize the electromagnetic lock, but will not turn off the audible alarm. The audible alarm will also begin sounding if a forced entry occurs while the system is armed.

In the event of a fire alarm, the electromagnetic lock will immediately de-energize to unlock the door. Upon resetting the fire alarm, the system will return to normal standby operation.

Model	Description	List Price
1490-21	1 zone card	\$1,020
1490-22	2 zone cards	\$1,550
1490-23	3 zone cards	\$1,960
1490-24	4 zone cards	\$2,370

ACSI 1490 Application

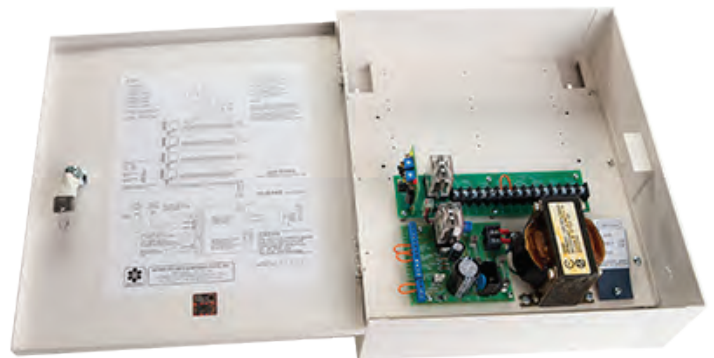
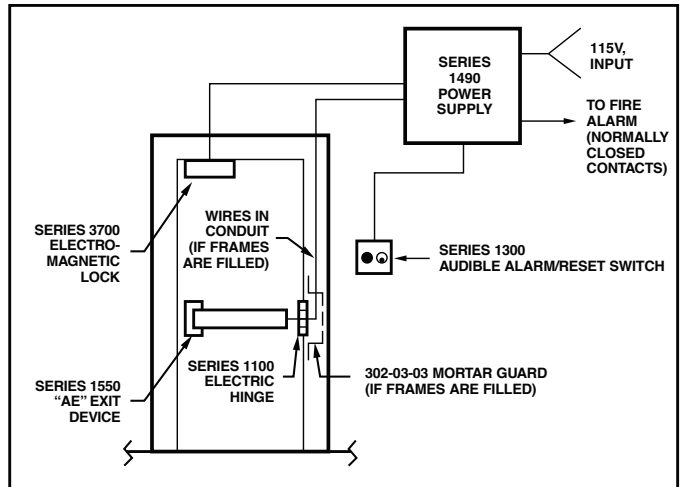

1490-21



Series 1400 | Power Supplies

Series 1400 Power Supply Specifications

ACSI Series 1400 Power Supplies are designed and manufactured by ACSI engineers to operate a variety of electric locking devices that will meet the most sophisticated specifications.

ACSI system engineers are available to assist you in the selection of the power supply that best meets your application. All ACSI designed systems include riser diagrams and point-to-point wiring diagrams that allow ease of interface with life-safety and security systems.

Input

1406, 1426, 1490

120VAC, 0.75A, 60Hz

1406BB, 1426BB

120VAC, 1.08A, 60Hz

1410, 1420, 1440, 1400-6100

120VAC, 0.9A, 50/60Hz

240VAC, 0.6A, 50/60Hz

1451

115VAC, 0.6A, 50/60Hz

1452

115VAC, 0.6A, 50/60Hz

Output

1406, 1426

1550 Device Outputs: 40VDC, 1.5A (combined) Filtered/Unregulated

Auxiliary 24V Output: 24VDC, 0.25A Filtered/Regulated

Auxiliary 12V Output: 12VDC, 0.25A Filtered/Regulated

1406BB, 1426BB

1550 Device Outputs: 40VDC, 1.8A (combined) Filtered/Unregulated

Auxiliary 24V Output: 24VDC, 0.2A Filtered/Regulated

1490

24VDC, 2A Filtered/Unregulated

1420, 1440, 1400-6100

24VDC, 2A Filtered/Regulated

1410

24VDC, 2.2A Filtered/Regulated

1451

12VDC or 24VDC, 1A Filtered/Regulated

1452

12VDC or 24VDC, 1.75A Filtered/Regulated

Enclosure Dimensions/Type

1406, 1410, 1420, 1426, 1440, 1400-6100

10"x10"x4", NEMA Type 1 Screw Cover Junction Box

1406BB, 1426BB

12"x16"x4", NEMA Type 1 Screw Cover Junction Box

1490

12"x14"x4", Surface Mount Cabinet w/Hinged Door and Keyed Lock

1451, 1452

13.5"x13"x3.25", Surface Mount Cabinet w/Hinged Door and Cam Key Lock

Enclosure Weight

1410

9 lbs (with all four plug-in boards installed onto motherboard)

1406, 1426

12 lbs

1406BB, 1426BB

26 lbs (with batteries)

1420, 1440, 1400-6100

8 lbs

1490

15 lbs (with all zone cards installed)

1451, 1452

18 lbs (with batteries)



Series 1500

Electric Exit Devices

Von Duprin

Corbin Russwin

Sargent

Yale

Dorma

Hager

Jackson

DormaKaba Commercial Hardware

BEST

Design Hardware

PDQ

First Choice

Falcon

Arrow

and more



2720 Clark Avenue
St. Louis, MO 63103
(314) 652-5588
(314) 652-2090 FAX

www.acsi-inc.com

Series 1500 | Electric Exit Devices

You supply the exit device and ACSI supplies high quality UL Listed modifications to a wide range of manufacturers' exit devices. ACSI engineers and technicians are available to provide system design, wiring diagrams, and a variety of technical services.

1550-MD Electric Motor Latch Retraction

ACSI Series 1550-MD Electric Motor Latch Retraction modification/kit provides a remote means of locking or unlocking exit devices.

- Simultaneous electric latch retraction and dogging (push bar depressed)
- UL Listed for both panic and fire exit hardware
- Available for mortise, rim, concealed and surface vertical rod exit devices
- Field or factory installed
- Quiet operation
- Continuous duty rated
- Low power consumption
- 24VDC operation
 - ACSI Series 1400 power supplies recommended
- Interface with life-safety systems
- Non-polarized leads
- On-board diagnostic LEDs
- Automatic retry



1550K-MDS



1550K-MDV



1550K-MDC



1550K-MDF



1550K-MDT



1550K-MDD



1550K-MDP



1550K-MDH



1550K-MDO

Model	Manufacturer's Series	List Price
1550K-MDV	Von Duprin 33A/35A, 98/99	\$700
1550K-MDV22	Von Duprin 22	\$780
1550K-MDC	Corbin Russwin ED4000, ED5000, Yale 7000	\$700
1550K-MDD	Dorma 9000	\$700
1550K-MDT	Hager 4500, 4600 PDQ 6200 DormaKaba Commercial QED100, QED200	\$780
1550K-MDO	Falcon 1690, 1790 First Choice 3600, 3700	\$700
1550K-MDS	Sargent 80 Arrow 1000, 3000, 4000	\$780
1550K-MDP	Best Precision 2000, 5000	\$780
1550K-MDF	Falcon 24, 25	\$780
1550K-MDH	Design Hardware 1000 MARKS USA M9900	\$780
1550K-MDY	Yale 6000	\$780
1550K-MDAEX	Adams Rite EX76, EX76W, EX88, EX88W	\$780
1550K-MDX	Dorex 9500	\$780
1550-MDA*	Adams Rite 3000, 8000	\$800
1550-MDR*	Regent 5700	\$800
1550-MDJ*	Jackson 20	\$800

*Not available as a field installable kit. Factory installation required.



Series 1500 | Electric Exit Devices

1560/1570 Electric Trim Control

ACSI Series 1560/1570 Electric Trim Control modification provides a remote means of locking or unlocking outside lever handle trims of exit devices.

- Fail Safe (Power Lock)
 - Outside trim is locked when power is applied and unlocked when power is removed. Trim control will unlock in the event of a power failure.
- Fail Secure (Power Unlock)
 - Outside trim is unlocked when power is applied and locked when power is removed. Trim control will lock in the event of a power failure.
- Continuous duty rated
- Low power consumption
- 24VDC, 24VAC, 12VDC, or 12VAC operation
 - ACSI Series 1400 power supplies recommended
- Interface with life-safety systems



1570-996L-24VAC/DC

1510/1520 Electric Mortise Exit Control

ACSI Series 1510/1520 Electric Mortise Exit Control modification provides a remote means of locking or unlocking mortise exit devices.

- UL Listed
- Fail Safe (Power Lock)
 - Outside trim is locked when power is applied and unlocked when power is removed. Lockset will unlock in the event of a power failure.
- Fail Secure (Power Unlock)
 - Outside trim is unlocked when power is applied and locked when power is removed. Lockset will lock in the event of a power failure.
- Continuous duty rated
- Low power consumption
- 24VDC, 24VAC, 12VDC, or 12VAC operation
 - ACSI Series 1400 power supplies recommended
- Interface with life-safety systems



ME1520C-00-1-7500-24VAC/DC

Series 1500 | Electric Exit Devices

Electric Exit Device Modification Listing

Note: If you do not find the lock of your choice listed, please consult with our factory engineering staff. We may request that you send a sample for further evaluation.

Arrow	Corbin Russwin	Dorma	Falcon	BEST	Sargent	Von Duprin	Yale
1000, 3000	ED4000	9000	24, 25	2000	80	33A/35A**	7000
4000	ED5000		1690, 1790	5000		22, 98/99**	6000
Adams Rite	Design Hardware	Hager	Jackson	PDQ	Regent	DormaKaba Commercial Hardware	
3000	1000	4500	20	6200	5700	QED100, QED200	
EX76, EX76W, EX88, EX88W		4600					
Dorex	First Choice	MARKS USA					
9500	3600, 3700	M9900					

** Not available in Von Duprin 48 function.

Series 1500 | Electric Exit Devices

How to Order

1 EXIT DEVICE	2 MODIFICATION #	3 LOCK PART #	4 OPERATING VOLTAGE	5 OPTIONS	6 QUICK CONNECT SYSTEM	7 HANDING
RE	1550-MD	FULL PART	24VDC	AE	QC1	LHR
VR	1560	NUMBER	24VAC/DC	LM	QC2	RHR
ME	1570		12VDC		QC3	
	1510		12VAC/DC			
	1520					

Examples:

1 EXIT DEVICE	2 MODIFICATION #	3 LOCK PART #	4 OPERATING VOLTAGE	5 OPTIONS	6 QUICK CONNECT SYSTEM	7 HANDING
RE	1550-MD	8800 (SARGENT)		LM	QC2	RHR
ME	1520	9975 (VON DUPRIN)	12VAC/DC		QC3	LHR
VR	1570	996L R/V	24VDC	AE	QC1	RHR

1. Exit Device

(Select type of lock to be modified) LIST PRICE

RE	Rim Exit Device	STD
VR	Vertical Rod Exit Device	STD
ME	Mortise Exit Device	STD

2. Modification Number

(Select type of lock modification required) LIST PRICE

1550-MD	Motor Latch Retraction	\$800
1560	Fail Safe Trim Control	\$340
1570	Fail Secure Trim Control	\$340
1510	Fail Safe Mortise Exit Control	\$340
1520	Fail Secure Mortise Exit Control	\$340

3. Lock Part Number

(Enter manufacturers full part number)

4. Operating Voltage

Required for 1510/1520/1560/1570 modifications LIST PRICE

24VDC	STD
24VAC/DC	\$20
12VAC/DC	\$200

5. Options

LIST PRICE

AE	Authorized Egress Monitors the use of the push bar. The AE Switch can be used to: • Signal a control console when the push bar is depressed • Activate a door alarm • Control an electromagnetic lock for egress • Shunt a door alarm to allow egress	\$120
LM	Latch Bolt Monitor Monitors the full extension of the latch bolt or rods.	\$120

6. Quick Connect System

(Select type of system to be modified) LIST PRICE

QC1	ACSI Quick Connect System	\$60
QC2	ASSA Connect System	Consult Factory
QC3	Allegion Connect System	Consult Factory

7. Handing

LIST PRICE

RHR	Right Hand Reverse	STD
LHR	Left Hand Reverse	STD

Series 1500 | Electric Exit Devices

Motor Electric Latch Retraction Comparison Chart

Manufacturer	Latch Retraction Part #	Power Supply Part #	Latch Bolt Monitor Part #	Request-to-Exit
ACSI	1550-MD	1420, 1440, 1451, 1452	LM	AE
Von Duprin	QEL	902	LX	RX
Sargent	56	3510	53	55
Dorma	MLR	PS532RF	LM	MS
Adams Rite	SE	PS-SE	LM	M1
Hager	MLR	2903, 2904	LM	RX
Corbin Russwin	MELR	BPS-24	M91	M92
BEST	MLR	RPSMLR2	LS	TS

Exit Device Switch Kits

ACSI Series K Switch Kits are field installed in exit devices. Series K Switch Kits include a SPDT (Single Pole Double Throw) switch assembly with long wire leads and easy-to-follow installation instructions. K Switch Kits may be used to:

- Provide instant release of magnetic locks for free egress
- Activate a door alarm
- Signal a control console when the push bar of an exit device is depressed
- Shunt a door alarm to allow free egress

Model	Manufacturer	List Price
K-100	Von Duprin 22, 33A/35A, 98/99	\$90
K-200	Von Duprin 22, 33A/35A, 98/99 (2-SPDT switches)	\$130
K-123	Latch Bolt Monitor for Von Duprin 33A/35A, 98/99	\$90
K-102	Von Duprin 88	\$90
K-103	Sargent 80, Arrow 1000, 3000, 4000 Dorex 9500	\$90
K-203	Arrow 1000, 3000, 4000 Sargent 80 (1-DPDT switch) Dorex 9500	\$130
K-104	Sargent 9600, 9700, 9800, 9900	\$90
K-105	Sargent 9300, 9400, 9500	\$90
K-106	Adams Rite 3000, 8000	\$90
K-107	Corbin Russwin 8000 Yale 2100	\$90
K-108	Jackson 1085, 1095	\$90
K-109	Corbin Russwin ED4000, ED5000 Yale 7000	\$90
K-110	Monarch 18, 19	\$90
K-111	Doromatic 990, 1090	\$90

Model	Manufacturer	List Price
K-112	Doromatic 1490, 1590	\$90
K-124	BEST Precision 2000, 5000	\$90
K-125	Dorma 9000	\$90
K-126	Hager 4500, 4600 PDQ 6200 DormaKaba Commercial QED100, QED200	\$90
K-226	Hager 4500, 4600 PDQ 6200 DormaKaba Commercial QED100, QED200 (2 SPDT switches)	\$130
K-128	Design Hardware 1000 MARKS USA M9900	\$90
K-129	Falcon 24, 25	\$90
K-130	Jackson 20	\$90
K-131	Falcon 1690, 1790	\$90
K-132	Adams Rite EX76, EX76W, EX88, EX88W	\$90
K-133	Yale 6000	\$90

Series 1500 | Electric Exit Devices

Electrical Specifications

1550-MD Motor Latch Retraction

- 24VDC, 1A Inrush, 400mA Holding

1510/1520

- 12VAC/DC, 612mA
- 24VAC/DC, 330mA

1560/1570

- 12VAC/DC, 612mA
- 24VAC/DC, 330mA

Series 1550 Typical Installation

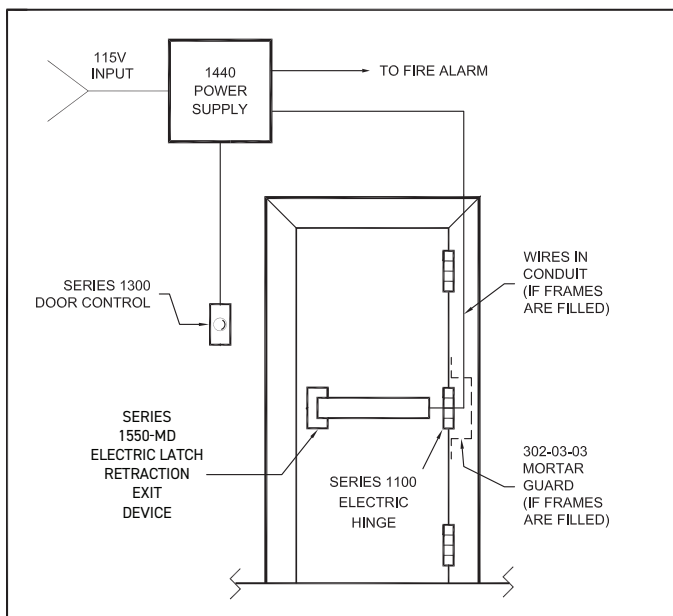

ACSI Automated Door Opening System

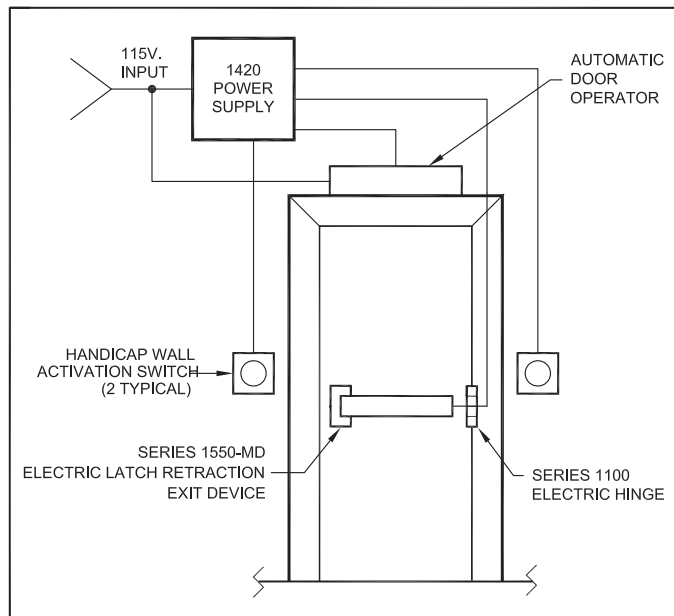

Series 1500

Electric Locks

Schlage

Corbin Russwin

Sargent

Yale

BEST

Hager

DormaKaba Commercial Hardware

PDQ

Falcon

Arrow

Design Hardware

Tell Manufacturing

Baldwin

and more

The ACSI logo is rendered in a large, bold, white sans-serif font. The letters are closely spaced and have a slight shadow effect, making them stand out against the dark green background of the page.

2720 Clark Avenue
St. Louis, MO 63103
(314) 652-5588
(314) 652-2090 FAX

www.acsi-inc.com

Series 1500 | Electric Locks

ACSI supplies high quality UL Listed modifications to a wide range of manufacturers' locksets. Series 1500 electric locks provide safety and security for stairtower doors or controlled areas where both locking and latching are required. The Series 1500 locks allow remote electric locking or unlocking and/or motorized latch retraction while conforming to life-safety codes. Series 1500 locks are available in motor-controlled or solenoid-controlled in both mortise and cylindrical locks. Consult factory for solenoid-controlled locks.

Features

- UL Listed
- California State Fire Marshall approved
- Fail Safe (Power Lock)
 - Outside trim is locked when power is applied and unlocked when power is removed (storeroom function when energized). Lockset will unlock in the event of a power failure (passage function).
- Fail Secure (Power Unlock)
 - Outside trim is unlocked when power is applied and locked when power is removed. Lockset will lock in the event of a power failure.
- 1500MLR-Motor Drive Latch Retraction
 - Outside trim (or both outside and inside trim depending on the lock function) is locked. The main latch bolt is retracted when power is applied. The main latch bolt is extended in the event of a power failure.
- Simple user selectable fail safe/fail secure operation in motor-controlled locks
- Continuous duty rated
- Low power consumption
- 24VDC, 24VAC, 12VDC or 12VAC operation
- When key cylinders are provided in the locks, the latch bolt may be momentarily retracted with key even though electrically locked.
- Note:** Locks that are electrically unlocked may not be locked via the key cylinder.
- Wide variety of monitoring options are available
- Interface with life-safety systems

Applications

Doors in stairtowers, offices, classrooms, interlocks, elevator lobbies, laboratories, computer rooms, cashier stations, hospital equipment rooms, pharmaceutical storage rooms

Typical Installation

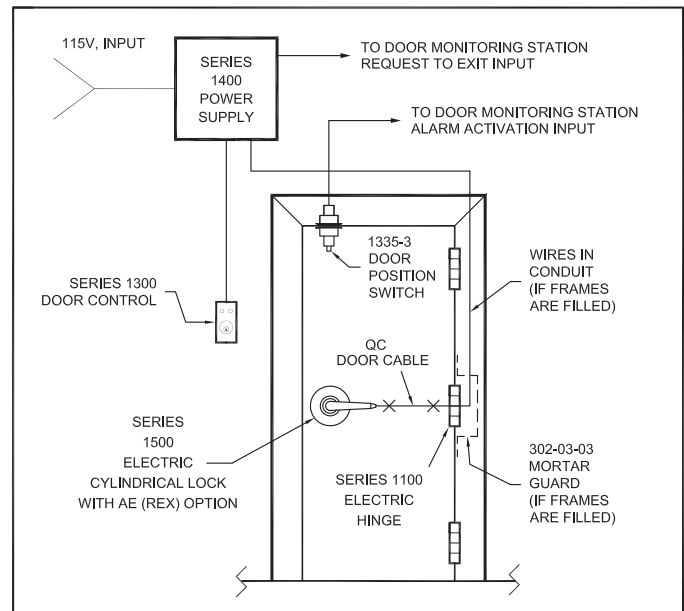
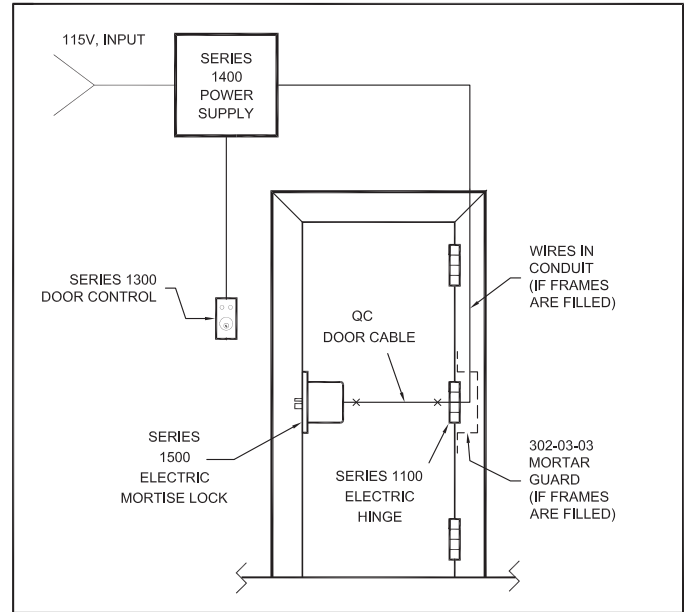

Series 1500 | Electric Locks

How to Order

1 LOCK TYPE	2 MODIFICATION #	3 OPTIONS	4 LOCKING	5 LOCK PART #	6 OPERATING VOLTAGE	7 QUICK CONNECT SYSTEM	8 HANDING
M	1520M	AE	1	FULL	12/24V	QC1	RH
C	1510M	LM	2	PART	24VDC	QC2	LH
	1520	SM		NUMBER	24VAC/DC	QC3	RHR
	1510	DM			12VDC		LHR
	1500	DMS			12VAC/DC		
	1500MLR	DPS					
	1520MLR	LMR					
	1510MLR						

Example:

LOCK TYPE	MODIFICATION #	OPTIONS	LOCKING	LOCK PART #	OPERATING VOLTAGE	QUICK CONNECT CABLE	HANDING
M	1520M	AE	1	L9070 (SCHLAGE)	12/24V	QC3	RH

1. Lock Type

(Select type of lock to be modified) LIST PRICE

M	Mortise Lock	STD
C	Cylindrical Lock	+\$30

2. Modification Number

(Select type of lock to be modified) LIST PRICE

1520M*	Fail Secure Motor-Controlled	\$300
1510M*	Fail Safe Motor-Controlled	\$300
1520	Fail Secure Solenoid-Controlled	\$300
1510	Fail Safe Solenoid-Controlled	\$300
1500MLR	Latch Retraction	\$1,300
M1520MLR*	Latch Retraction/Fail Secure Motor-Controlled	\$1,600
M1510MLR*	Latch Retraction/Fail Safe Motor-Controlled	\$1,600
1500	Monitor Only	See Options

*NOTE: *Factory ships Fail Secure as default (unless specified Fail Safe). Field selectable to Fail Safe.*

Series 1500 | Electric Locks

How to Order (Cont.)

3. Options <input type="checkbox"/> <input type="checkbox"/> <input type="checkbox"/> <input type="checkbox"/> <input type="checkbox"/> <input type="checkbox"/> <input type="checkbox"/>		LIST PRICE
AE	Authorized Egress (Mortise or Cylindrical Lock) Monitors the use of the INSIDE trim when the OUTSIDE trim is locked. The AE switch can be used to: • Shunt a door alarm to allow egress • Signal a control console when the trim is activated • Activate a door alarm • Control an electromagnetic lock for egress	\$150
LM	Latch Bolt Monitor (Mortise Lock) Monitors the full extension of the main latch.	\$150
SM	Security Monitoring (Mortise Lock) Monitors the locked or unlocked status and the dead latch status in series.	\$280
DM	Deadbolt Monitor (Mortise Lock) Monitors the full extension of the deadbolt.	\$260
DMS	Deadbolt Monitor Secured (Mortise Lock) Monitors the full extension of the deadbolt disabling the electrical control of a fail secure lockset locking the OUTSIDE trim. Retracting the deadbolt enables the electrical control. Free egress at all times. • Uses include private rooms, restrooms, and lactation rooms.	\$260
DPS	Door Position Sensor (Mortise Lock) Monitors the door position. A magnetic sensor mounted in the mortise lock reacts to the proximity of a magnet mounted behind the ASA strike.	\$200
AM	Auxiliary Latch Monitor (Mortise Lock) Monitors the position of the dead latch.	\$150
LB	Locking Bar Monitor (Mortise Lock) Monitors the position of the locking bar.	\$150
KM	Key Cylinder Monitor (Mortise Lock) Monitors the use of a key for retracting the latch.	\$150
LMR	Latch Bolt Monitor Retracted (Mortise Lock with MLR) Monitors the full retraction of the main latch. A dry contact closure will occur 0.5 seconds after the full retraction of the main latch bolt under power and will remain until power is removed or if the main latch bolt unintentionally extends.	\$180
MK-10	Authorized Egress Kit Field installable for Schlage L series mortise lock.	\$90

4. Locking <input type="checkbox"/> <input type="checkbox"/> <input type="checkbox"/> <input type="checkbox"/> <input type="checkbox"/> <input type="checkbox"/>		LIST PRICE
1	Standard control locks outside (secure side) trim.	STD
2	Locks both sides – mortise locks only.	\$40

5. Lock Part No.

Distributors supply ACSI with mortise, cylindrical or unit locks for modification. Please supply the lock manufacturer's full part number.
Example: L9070, 8237, 8808, ND70, 3357, etc.
Note: Refer to the last page of this catalog section for a complete listing of locks required by ACSI.

6. Operating Voltage <input type="checkbox"/> <input type="checkbox"/> <input type="checkbox"/> <input type="checkbox"/> <input type="checkbox"/> <input type="checkbox"/> <input type="checkbox"/> <input type="checkbox"/>		LIST PRICE
12/24V	Motor-Controlled Locks, automatic 12V or 24V, AC or DC operating voltage	STD
24VDC	Solenoid-Controlled Locks	\$100
24VAC/DC	Solenoid-Controlled Locks	\$100
12VDC	Solenoid-Controlled Locks	\$200
12VAC/DC	Solenoid-Controlled Locks	\$200

Note: For Solenoid-Controlled locks consult factory.

7. Quick Connect System <input type="checkbox"/> <input type="checkbox"/> <input type="checkbox"/> <input type="checkbox"/> <input type="checkbox"/> <input type="checkbox"/> <input type="checkbox"/> <input type="checkbox"/>		
QC1	ACSI Quick Connect System	\$60
QC2	ASSA Connect System	Consult Factory
QC3	Allegion Connect System	Consult Factory

8. Handing <input type="checkbox"/> <input type="checkbox"/> <input type="checkbox"/> <input type="checkbox"/> <input type="checkbox"/> <input type="checkbox"/> <input type="checkbox"/> <input type="checkbox"/>		LIST PRICE
RH	Right Hand	STD
LH	Left Hand	STD
RHR	Right Hand Reverse	STD
LHR	Left Hand Reverse	STD

Series 1500 | Electric Locks

Electric Mortise Lock Bodies

ACSI Stocks Electric Mortise Lock Bodies available in Schlage, Corbin Russwin, Sargent, Yale, BEST and Falcon are available as motor-controlled. Motor-controlled locks are field selectable for fail safe or fail secure and have automatic 12V or 24V, AC or DC operation. ACSI 1500MLR motorized latch retraction is available in Schlage L9070B and also available in 1520MLR, 1510MLR for dual latch retraction and lock/unlock features. A variety of monitoring options are available. Consult factory for solenoid-controlled locks.

Motor-Controlled				LIST PRICE
M1510M	L9070B	12/24V	Schlage Fail Safe	\$920
M1510M	L9453B	12/24V	Schlage Deadbolt Fail Safe	\$1,200
M1510M	2055B	12/24V	Corbin Russwin Fail Safe	Consult Factory
M1510M	8237B	12/24V	Sargent Fail Safe	Consult Factory
M1510M	8808B	12/24V	Yale Fail Safe	Consult Factory
M1510M	MA561B	12/24V	Falcon Fail Safe	Consult Factory
M1520M	L9070B	12/24V	Schlage Fail Secure	\$920
M1520M	L9453B	12/24V	Schlage Deadbolt Fail Secure	\$1,200
M1520M	2055B	12/24V	Corbin Russwin Fail Secure	Consult Factory
M1520M	8237B	12/24V	Sargent Fail Secure	Consult Factory
M1520M	8808B	12/24V	Yale Fail Secure	Consult Factory
M1520M	MA561B	12/24V	Falcon Fail Secure	Consult Factory
M1500MLR	L9070B	24VDC	Schlage Latch Retraction	\$1,850
M1510MLR	L9070B	24VDC	Schlage Latch Retraction/ Fail Safe	\$2,150
M1520MLR	L9070B	24VDC	Schlage Latch Retraction/ Fail Secure	\$2,150

Solenoid-Controlled				LIST PRICE
M1510	L9070B	24VAC/DC	Schlage Fail Safe	Consult Factory
M1510	2055B	24VAC/DC	Corbin Russwin Fail Safe	Consult Factory
M1510	8237B	24VAC/DC	Sargent Fail Safe	Consult Factory
M1510	8808B	24VAC/DC	Yale Fail Safe	Consult Factory
M1510	45H7RB	24VAC/DC	BEST Fail Safe	Consult Factory
M1510	MA561B	24VAC/DC	Falcon Fail Safe	Consult Factory
M1520	L9070B	24VAC/DC	Schlage Fail Secure	Consult Factory
M1520	2055B	24VAC/DC	Corbin Russwin Fail Secure	Consult Factory
M1520	8237B	24VAC/DC	Sargent Fail Secure	Consult Factory
M1520	8808B	24VAC/DC	Yale Fail Secure	Consult Factory
M1520	45H7RB	24VAC/DC	BEST Fail Secure	Consult Factory
M1520	MA561B	24VAC/DC	Falcon Fail Secure	Consult Factory



Sargent M1520M



Corbin M1520M



Schlage M1520M

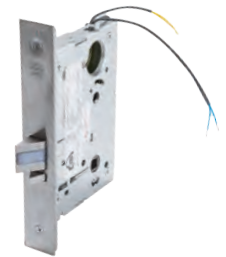

Yale M1520M



Falcon M1520M



BEST M1520

Electrical Specifications

M1510M / M1520M

- 12/24V, 250mA Inrush, 10mA Holding

M1510 / M1520

- 12VAC/DC, 612mA
- 24VAC/DC, 330mA

MU1510 / MU1520

- 12VAC/DC, 612mA
- 24VAC/DC, 330mA

M1500MLR

- 24VDC, 625mA Inrush, 150mA Holding

Series 1500 | Electric Locks

Electric Cylindrical Locks

ACSI Stocks Electric Cylindrical Locks available in Schlage, Corbin Russwin, Sargent and Yale. The locks are available as motor-controlled. Motor-controlled locks are field selectable for fail safe or fail secure and have automatic 12V or 24V, AC or DC operation. Authorized Egress (Request-to-Exit) option is also available. Consult factory for solenoid-controlled locks.

Motor-Controlled						LIST PRICE
C1510M*	ND70B	12/24V			Schlage Fail Safe	\$900
C1510M	10G04B	12/24V	LL	626	Sargent Fail Safe	Consult Factory
C1510M	3357B	12/24V	NZD	626	Corbin Russwin Fail Safe	Consult Factory
C1510M	5405LNB	12/24V	AU	626	Yale Fail Safe	Consult Factory
C1520M*	ND70B	12/24V			Schlage Fail Secure	\$900
C1520M	10G04B	12/24V	LL	626	Sargent Fail Secure	Consult Factory
C1520M	3357B	12/24V	NZD	626	Corbin Russwin Fail Secure	Consult Factory
C1520M	5405LNB	12/24V	AU	626	Yale Fail Secure	Consult Factory

* Specify trim style, format and finish. Available in Rhodes, Sparta and Athens trim style. Finishes available in 626, 625 and 613. Add \$60 list for 613 finish. Add \$60 list for HD, RD, TD.

Electrical Specifications

C1510M / C1520M

- 12/24V, 250mA Inrush, 10mA Holding



Sargent C1520M



Schlage C1520



Yale C1520M



Corbin C1520M

Series 1500 | Electric Locks

Electric Lock Comparison Chart

ACSI	Arrow	BEST	Corbin Russwin	Design Hardware	Falcon
M1510M/M1520M-1**			20906, 20907	E-M-07-FS/FSE	
M1510M/M1520M-2**			20914, 20915, 20932	E-M-30-FS/FSE	
M1510-1	A17-177, B17-177	EWEL	20903, 20910	E-M-07-FS	M851
M1510-2		WWEL	20901, 20920	E-M-30-FS	M811
M1520-1	A17-178, B17-178	EWEU	20905, 20930	E-M-07-FSE	M881
M1520-2		WWEU	20940	E-M-30-FSE	M821
C1510M/C1520M-1**				E-Z-86-FS/FSE	
C1510-1	Q12-177, H12-177	DEL	33903	E-Z-86-FS	T851
C1520-1	Q12-178, H12-178	DEU	33905	E-Z-86-FSE	T881
AE	RE	RQE	M92	REX	RX*
LM*	LM*	LS*	M91*	LM*	
SM*	SM*		M105*	SM*	
DM*					
DMS*					
DPS*		DS*			

**Motor-controlled
*Available in Mortise only

ACSI	Hager	PDQ	Sargent	Schlage	DormaKaba Commercial Hardware	Yale
M1510M/M1520M-1**	3880EL/EU	MR199A**	8270, 8271	L9090EL/EU L9092EL/EU L9094EL/EU		
M1510M/M1520M-2**		MR200	8272, 8273	L9091EL/EU L9093EL/EU L9095EL/EU		
M1510-1	3880EL		8270	L9080EL		8890
M1510-2			8272	L9082EL		9984-2
M1520-1	3880EU		8271	L9080EU		8891
M1520-2			8273	L9082EU		8895-2
C1510M/C1520M-1**	3480EL/EU			ND80EL/EU		
C1510-1	3480EL	GT199FS	10G70	ND80EL	QCL192	5490
C1520-1	3480EU	GT199FSC	10G71	ND80EU	QCL194	5491
AE	RX	REX	RX	RX	X	REX
LM*	LM*	LM*	LX*	LX*		LBM*
SM*						
DM*			DX*			
DMS*			DX*			
DPS*	DPM*					

**Motor-controlled
*Available in Mortise only

Series 1500 | Electric Locks

Electric Lock Modification Listing

Note: If you do not find the lock of your choice listed, please consult with our factory engineering staff. We may request that you send a sample for further evaluation.

Manufacturer	Mortise Locks	Cylindrical Locks
Arrow	AM17, BM17	QL82
Baldwin	6065*, 6065LS*	
BEST	45H7R*	
Corbin Russwin	2055	3357
Design Hardware	M-05, M-13	Z-84
Falcon	MA561, MA571	T561
Hager	3850, 3856	3480
PDQ	MR148*	
Sargent	8237, 8225	10G04
Schlage	L9050, L9070 L9080** (see note below), L9453	ND70, ND80 ND94
DormaKaba	QM160*	QCL170
Tell Manufacturing		LC2486
Yale	8800, 8847	5405LN

*Available in solenoid-controlled only

**Schlage L9080 must be supplied with extra spring cage to compensate for lever sag of outside trim.

Lock Schematics

AE – Authorized Egress

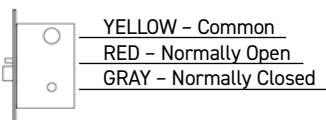

LM – Latch Bolt Monitor

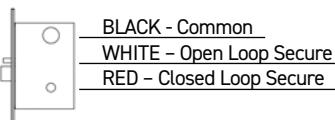

SM – Security Monitoring

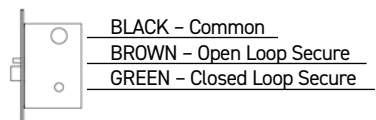

DM – Deadbolt Monitor

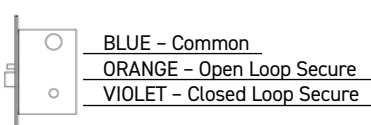

DPS – Door Position Sensor

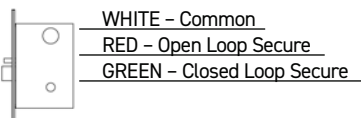

M1510 / M1520 / M1510M / M1520M
DMS – Deadbolt Monitor Secured

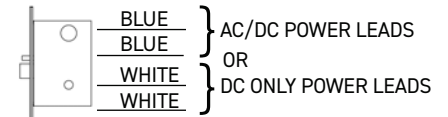

AE – Authorized Egress

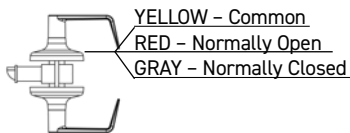

C1510 / C1520 / C1510M / C1520M



Red ty-wrap on leads designates 12V only.

Red ty-wrap on leads designates 12V only.
1500MLR | LMR -latch bolt monitor retracted

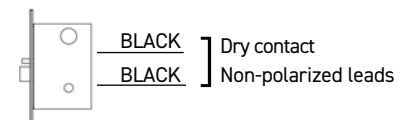

AM – Auxiliary Latch Monitor

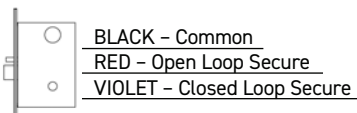

LB – Locking Bar Monitor

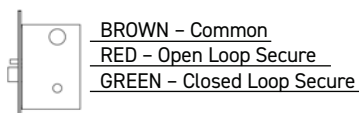

KM – Key Retraction Monitor

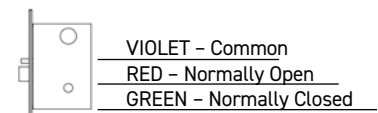

Series 3700

Electromagnetic Locks

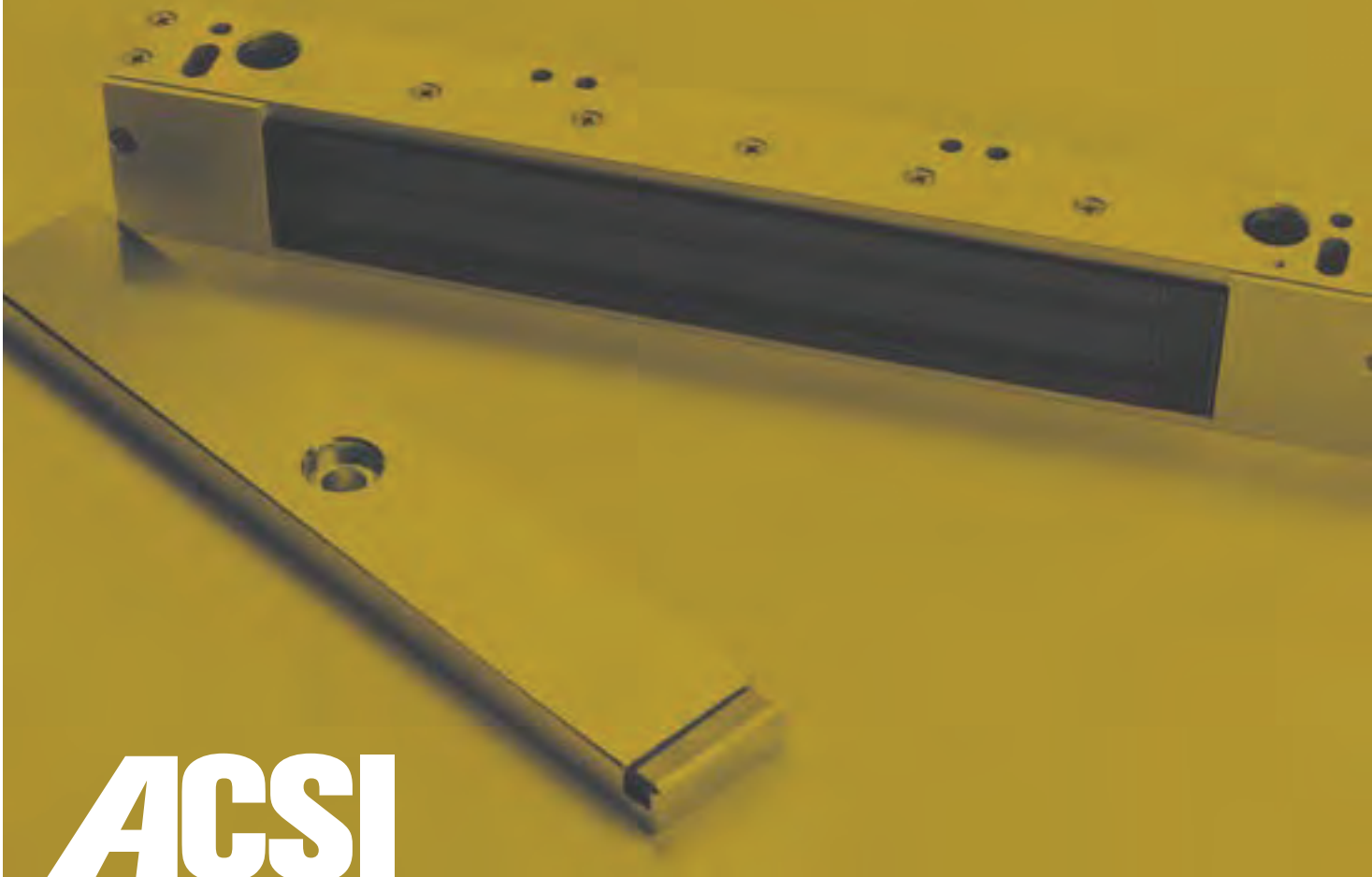

ACSI

2720 Clark Avenue
St. Louis, MO 63103
(314) 652-5588
(314) 652-2090 FAX

www.acsi-inc.com

Series 3700 | Electromagnetic Locks

ACSI Series 3700 UL Listed Electromagnetic Locks combine high security features with fail safe operation and conform with life-safety codes. The Series 3700 is designed for single or pairs of outswing or inswing doors.

Features

- UL Listed
- Variety of models available
- Positive fail safe security
- No moving parts - maintenance free
- Low power consumption
- Built-in surge and spike protection
- Built-in door position sensor

Options

- Magnetic bond sensor
- Power LED
- Custom length housings
- Variety of architectural finishes
- Glass door brackets

Typical Installation

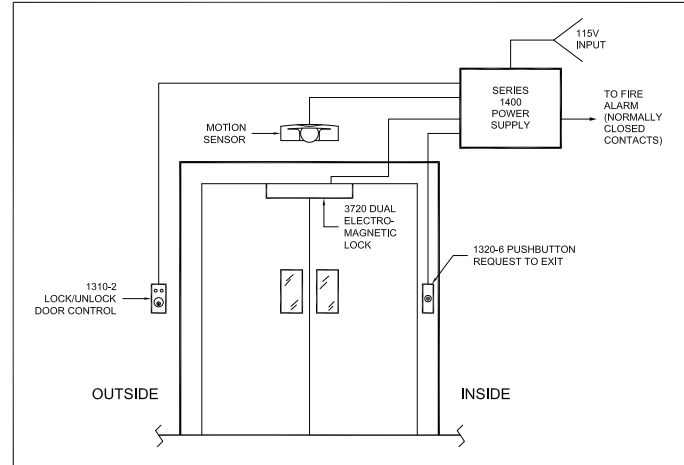

Electrical Specifications

- 12VDC, 500mA
- 24VDC, 250mA

How to Order

1. Model List Price	
3710	Single 1200 lb. magnetic lock (outswing) \$540
3711	Single 1200 lb. magnetic lock with Z bracket (inswing) \$690
3720	Double 1200 lb. magnetic lock (outswing) \$1,070
3721	Double 1200 lb. magnetic lock with Z bracket (inswing) \$1,350
3750	Single 1200 lb. magnetic lock for sliding doors \$720
3760	Single 300 lb. magnetic lock \$460
3770	Double 300 lb. magnetic lock \$930
3780	Single 600 lb. magnetic lock \$500
3790	Double 600 lb. magnetic lock \$1,010

2. Operating Voltage List Price	
24VDC	STD
12VDC	\$40

3. Finish List Price	
SA	Satin Aluminum STD
BA	Black Anodized POA
GA	Gold Anodized POA
DBN	Dark Brown Anodized POA
US3	Bright Brass POA
US4	Satin Brass POA
US26	Bright Chrome POA

4. Options List Price	
MBS	Magnetic bond sensor \$140
L1	1 LED (green or red) \$36
L2	2 LEDs (green and red) \$70
FP1	Filler plate, single magnet* \$86
FP2	Filler plate, double magnet* \$100
GLB-1	1/2" glass door bracket \$140
GLB-2	3/4" glass door bracket \$140
AB-1	Angle bracket for single magnet (1"x1"x14") \$140
AB-2	Angle bracket for double magnet (1"x1"x25") \$180
AB-3	Angle bracket for single magnet (1-1/2"x2-5/8"x14") \$140
AB-4	Angle bracket for double magnet (1-1/2"x2-5/8"x25") \$190

* Specify 1/2" or 5/8" thick.
 Note: Please consult the factory for custom length decorative housings.



Series 6100

Communicating Bath Door System



ACSI

2720 Clark Avenue
St. Louis, MO 63103
(314) 652-5588
(314) 652-2090 FAX

www.acsi-inc.com

Series 6100 | Communicating Bath Door System

ACSI Series 6100 Communicating Bath Door System is designed to coordinate access to a common bathroom facility from adjoining rooms. This system allows more efficient utilization of floor space in facilities by eliminating the need for a bathroom in each room.

Features

- Fail safe system - doors will unlock when power is removed
- Free egress at all times
- User privacy
- Eliminates accidental lock-out from either room to the bathroom
- Mechanical key override allows personnel to enter during an emergency
- 2A load capacity
- Inputs available for optional emergency release switch when urgent unlocking of the door is required
- Convenient field wiring of system components

Options

- Located above outside doors for emergency release:

Model	Description	List Price
1330-3	Emergency Release	\$288
1320-1MOM-ER	Pushbutton Switch marked "Emergency Release"	\$140



Model	Description	List Price
6100	Communication Bath Door System	\$1,130

Included Components

Qty	Description
1 Each	1400-6100 Power Supply
2 Each	Door Position Sensors
2 Each	Pushbuttons with indicator marked "Push to Lock"
2 Each	Indicators marked "Occupied"

Required Components

Qty	Description
2 Each	Electric Hinges, Model 1104*
2 Each	M1510 or C1510 Fail Safe Locks*

*Electric hinges and electric locks are not included, but must be ordered separately with the Series 6100 system.

Description of System Function

When the bathroom is not occupied, both doors are unlocked and all indicators are extinguished. Upon entering the bathroom from one of the rooms, the occupant depresses the inside pushbutton switch to lock both doors (both doors must be closed in order for them to lock). When the doors lock, the red indicators inside the bathroom indicate that both doors are locked from the outside. The green indicators outside the bathroom indicate that the bathroom is occupied.

Note: Both doors are always free egress and can be unlocked mechanically from the outside with a key. When the occupant exits either door, both doors automatically return to the unlocked condition and all indicators are extinguished.

Series 6100 | Communicating Bath Door System

How to Order

1 Model	2 Electric Locking Device	3 1104 Electric Hinge
6100	A or B	

1. 6100 System

6100	Communicating Bath Door System
------	--------------------------------

2. Electric Locking Device

Distributors supply ACSI with mortise or cylindrical locks for modification. Please supply the lock manufacturer's full part number.
 Example: L9070, 8237, 8808, ND70, 3357, etc.

A (2) M1510	Electric Mortise Locks
B (2) C1510	Electric Cylindrical Locks

3. 1104 Electric Hinges

Please specify manufacturer, weight, size and finish of the hinge required.
 (2) Hager BB1279 4.5x4.5 26D 1104
 (2) BEST FBB191 5.0x4.5 10B 1104

Note: System may also be furnished with an emergency release device; i.e., 1330-3 Emergency Release or 1320-1 Pushbutton Switch.

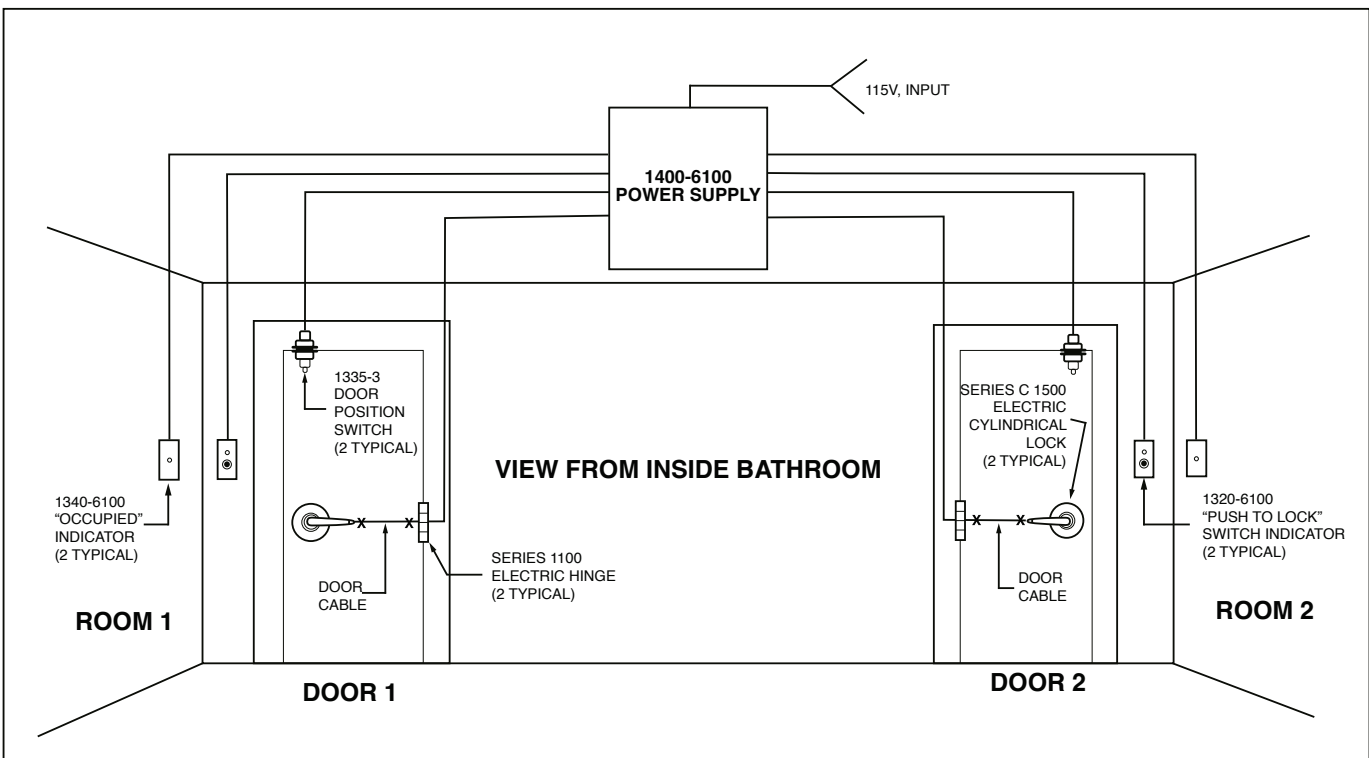

Series 8500

Gemini Locking Systems

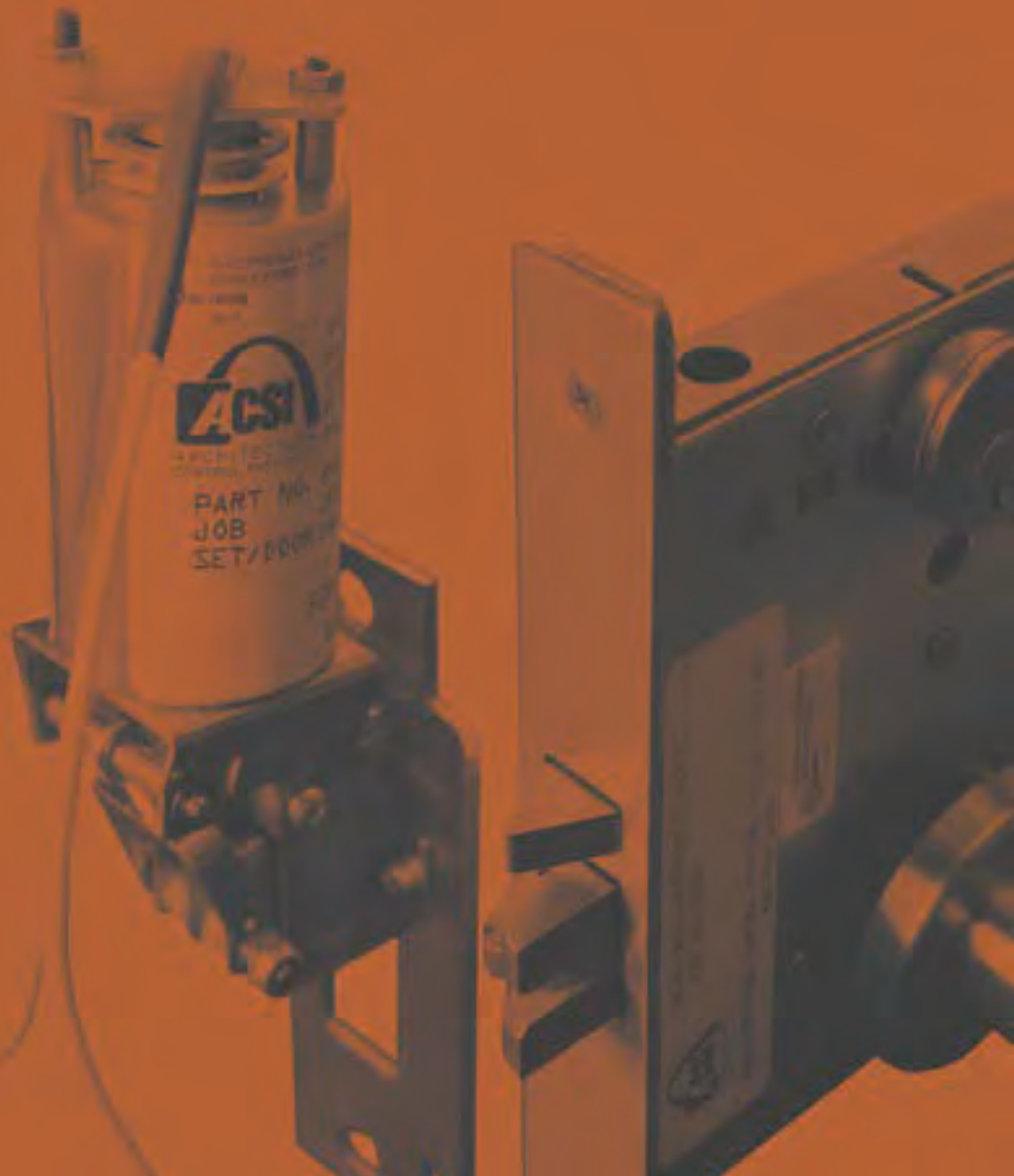

ACSI

2720 Clark Avenue
St. Louis, MO 63103
(314) 652-5588
(314) 652-2090 FAX

www.acsi-inc.com

Series 8500 | Gemini Locking Systems

ACSI Series 8500 Gemini Locking System provides safety and security for stairtower doors or controlled areas where both locking and latching are required. The Gemini system allows remote electric locking or unlocking while conforming to life-safety codes. The system consists of two components: a Gemini modified mortise lockset and a frame mounted Gemini operator.

Features

- UL Listed Gemini mortise lock - no special door prep
- UL Listed Gemini operator located in the frame
- Ability to work with a wide range of mortise lock manufacturers:
 - Arrow
 - Corbin Russwin
 - Schlage
- Fail Safe (Power Lock)
 - Outside trim is locked when power is applied and unlocked when power is removed (storeroom function when energized). Lockset will unlock in the event of a power failure (passage function).
- Fail Secure (Power Unlock)
 - Outside trim is unlocked when power is applied and locked when power is removed. Lockset will lock in the event of a power failure.
- 24VDC or 24VAC/DC
- Optional quick connect cable
- Continuous duty rated
- Heavy-duty stainless steel housing
- Security monitoring available
- Interface with life-safety systems

- Mechanical key override
 - When key cylinders are provided in the locks, the latch bolt may be momentarily retracted with key even though electrically locked.

Note: Locks that are electrically unlocked may not be locked via the key cylinder.

- Easy installation: Gemini operator fits easily into 2" face frames. Only one wiring termination.

Series 8500 Typical Installation

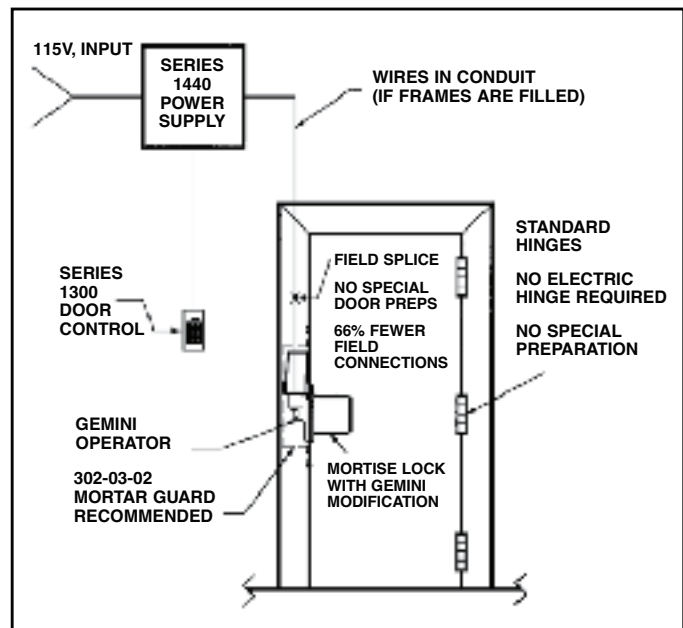

Series 8500 | Gemini Locking Systems

How to Order

1 GEMINI OPERATOR	2 LOCK TYPE	3 CONTROL MODE	4 OPERATING VOLTAGE	5 QUICK CONNECT CABLE	6 SECURITY MONITORING	7 FINISH	8 HANDING	9 LOCK PART #
8500	M1	PL	24VDC	QC	CLS	26D	LH	L9070
8500F	M2	PUL	24VAC/DC		OLS		RH	
							LHR	
							RHR	

Example:

GEMINI OPERATOR	LOCK TYPE	CONTROL MODE	OPERATING VOLTAGE	QUICK CONNECT CABLE	SECURITY MONITORING	FINISH	HANDING	LOCK PART #
8500	M1	PL	24VDC	QC	CLS	26D	LH	L9070

1. Gemini Operator

		LIST PRICE
8500	The standard Gemini operator is designed for 2" face frame applications and fits a standard ANSI 4-7/8" frame prep.	\$840
8500F	Also designed for 2" face frame applications, this operator is supplied with an oversized strikeplate for easy installation in retrofit applications.	\$860

6. Security Monitoring

		LIST PRICE
CLS	Closed Loop Secure – Monitor • When lock is secure (latch in strike-operator in locked position), monitor loop is a closed circuit. The circuit opens if security is breached.	\$200
OLS	Open Loop Secure – Monitor • When lock is secure (latch in strike-operator in locked position), monitor loop is an open circuit. The circuit closes if security is breached.	\$200

Note: Leave this space blank if not required.

2. Lock Type

		LIST PRICE
M1	Mortise lock with one side (lever or knob) locked	STD
M2	Mortise lock with both sides (lever and knob) locked	\$40

7. Finish

Specify US standard architectural hardware finish as required. **STD**

3. Control Mode

		LIST PRICE
PL	Power Lock (Fail Safe)	STD
PUL	Power Unlock (Fail Secure)	\$200

8. Handing

		LIST PRICE
LH	Left Hand	STD
RH	Right Hand	STD
LHR	Left Hand Reverse	STD
RHR	Right Hand Reverse	STD

4. Operating Voltage

		LIST PRICE
24VDC		STD
24VAC/DC		\$38

9. Lock Part Number

Distributors supply ACSI with mortise locks for modification. **STD**
Please supply the lock manufacturer's full part number.

Example: L9070, 2055, BM17

Note: Refer to the last page of this catalog section for a complete listing of locks required by ACSI.

5. Quick Connect Cable

		LIST PRICE
QC	An optional quick connect cable 10' in length with stripped wires at one end for splicing into an electrical box or power supply and with a connector on one end for quick connect to the Gemini operator is automatically supplied with a matching connector.	\$70

Accessories

		LIST PRICE
302-03-02	Gemini Mortar Guard, 15"	\$44

Note: Leave this space blank if not required.

Series 8500 | Gemini Locking Systems

Gemini Lock Modification Listing (Indicates Locksets that are UL Listed)

Note: If you do not find the lock of your choice listed, please consult with our factory engineering staff. We may request that you send a sample for further evaluation.

Arrow	Corbin Russwin	Schlage
AM17	2055	L9050
BM17		L9070
		L9080*

*L9080 must be supplied with extra spring cage to compensate for lever sag of outside trim.

Electrical Specifications

Gemini Operator
· 24VAC/DC, 600mA
Monitoring Contact Rating
· 0.5A @ 30VDC

Gemini Comparison Chart

ACSI-Gemini	SDC HiTower
Fail Safe	
8500-M1-PL	7550, 7540
8500-M2-PL	7530
8500-M1 or M2-PL*	7510, 7520
Fail Secure	
8500-M1-PUL	7570
8500-M2-PUL	7560

*Please consult the factory for proper part number.

ACSI	Description	SDC
CLS, OLS	Monitoring	9A, 69A
QC	Quick Connect Cable	SC-10
302-03-02	Mortar Guard for 2" Face Frame	7500-EB-S

